

HITACHI

Inspire the Next

SPLIT TYPE AIR CONDITIONER

INDOOR UNIT/OUTDOOR UNIT

MODEL
RAS-E10CZ/RAC-E10CZ

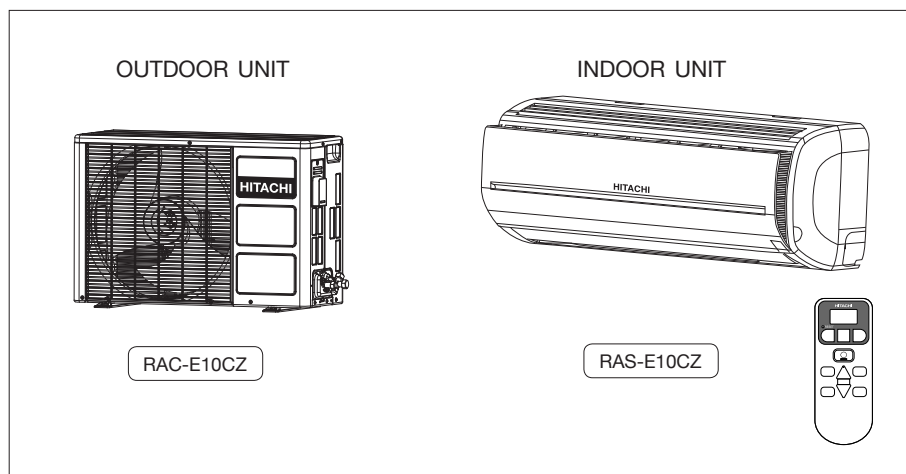

Instruction manual

To obtain the best performance, please read this instruction manual completely.

Page 1-20

Arahan pengendalian

Untuk mendapatkan prestasi yang tinggi, sila baca arahan ini sepenuhnya.

Muka surat 21-40



SAFETY PRECAUTION

- Please read the "Safety Precaution" carefully before operating the unit to ensure correct usage of the unit.
- Pay special attention to signs of "▲ Warning" and "▲ Caution". The "Warning" section contains matters which, if not observed strictly, may cause death or serious injury. The "Caution" section contains matters which may result in serious consequences if not observed properly. Please observe all instructions strictly to ensure safety.
- The sign indicate the following meanings.

	Make sure to connect earth line.		The sign in the figure indicates prohibition.
	Indicates the instructions that must be followed.		

- Please keep this manual after reading.

PRECAUTIONS DURING INSTALLATION

 WARNING	<ul style="list-style-type: none"> • Do not reconstruct the unit. Water leakage, fault, short circuit or fire may occur if you reconstruct the unit by yourself. 	
	<ul style="list-style-type: none"> • Please ask your sales agent or qualified technician for the installation of your unit. Water leakage, short circuit or fire may occur if you install the unit by yourself. 	
	<ul style="list-style-type: none"> • Please use earth line. Do not place the earth line near water or gas pipes, lightning-conductor, or the earth line of telephone. Improper installation of earth line may cause electric shock. 	
 CAUTION	<ul style="list-style-type: none"> • A circuit breaker should be installed depending on the mounting site of the unit. Without a circuit breaker, the danger of electric shock exists. 	
	<ul style="list-style-type: none"> • Do not install the unit near a location where there is flammable gas. The outdoor unit may catch fire if flammable gas leaks around it. 	
	<ul style="list-style-type: none"> • Please ensure smooth flow of water when installing the drain hose. 	

PRECAUTIONS DURING SHIFTING OR MAINTENANCE

 WARNING	<ul style="list-style-type: none"> • Should abnormal situation arises (like burning smell), please stop operating the unit and turn off the circuit breaker. Contact your agent. Fault, short circuit or fire may occur if you continue to operate the unit under abnormal situation. 	
	<ul style="list-style-type: none"> • Please contact your agent for maintenance. Improper self maintenance may cause electric shock and fire. 	
	<ul style="list-style-type: none"> • Please contact your agent if you need to remove and reinstall the unit. Electric shock or fire may occur if you remove and reinstall the unit yourself improperly. 	
	<ul style="list-style-type: none"> • If the supply cord is damaged, it must be replaced by the special cord obtainable at authorized service/parts centers. 	

PRECAUTIONS DURING OPERATION

 WARNING	<ul style="list-style-type: none"> • Avoid an extended period of direct air flow for your health. 	
	<ul style="list-style-type: none"> • Do not insert a finger, a rod or other objects into the air outlet or inlet. As the fan is rotating at a high speed, it will cause injury. Before cleaning, be sure to stop the operation and turn the breaker OFF. 	
	<ul style="list-style-type: none"> • Do not use any conductor as fuse wire, this could cause fatal accident. 	
	<ul style="list-style-type: none"> • During thunder storm, disconnect and turn off the circuit breaker. 	

PRECAUTIONS DURING OPERATION

ENGLISH

- The product shall be operated under the manufacturer specification and not for any other intended use.



- Do not attempt to operate the unit with wet hands, this could cause fatal accident.

- Do not direct the cool air coming out from the air-conditioner panel to face household heating apparatus as this may affect the working of apparatus such as the electric kettle, oven etc.



- Please ensure that outdoor mounting frame is always stable, firm and without defect. If not, the outdoor unit may collapse and cause danger.

- Do not splash or direct water to the body of the unit when cleaning it as this may cause short circuit.



- Do not use any aerosol or hair sprays near the indoor unit. This chemical can adhere on heat exchanger fin and blocked the evaporation water flow to drain pan. The water will drop on tangential fan and cause water splashing out from indoor unit.

- Please switch off the unit and turn off the circuit breaker during cleaning, the high-speed fan inside the unit may cause danger.



- Turn off the circuit breaker if the unit is not to be operated for a long period.

- Do not climb on the outdoor unit or put objects on it.

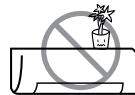

- Do not put water container (like vase) on the indoor unit to avoid water dripping into the unit. Dripping water will damage the insulator inside the unit and causes short-circuit.

- Do not place plants directly under the air flow as it is bad for the plants.



- When operating the unit with the door and windows opened, (the room humidity is always above 80%) and with the air deflector facing down or moving automatically for a long period of time, water will condense on the air deflector and drips down occasionally. This will wet your furniture. Therefore, do not operate under such condition for a long time.

- If the amount of heat in the room is above the cooling capability of the unit (for example: more people entering the room, using heating equipments and etc.), the preset room temperature cannot be achieved.

- This appliance is not intended for use by young children unless they have been adequately supervised by a responsible person to ensure that they can use the appliance safely.

- Young children should be supervised to ensure that they do not play with the appliance.

CAUTION

NAMES AND FUNCTIONS OF EACH PART

INDOOR UNIT

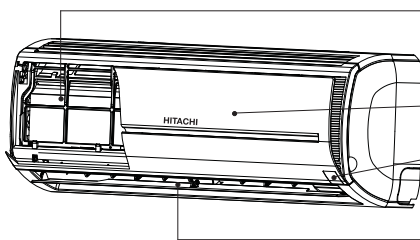

Air filter

To prevent dust from coming into the indoor unit.
(Refer page 16)

Front panel

Indoor unit indicators

Light indicator showing the operating condition.
(Refer page 5)

**Horizontal deflector • Vertical deflector
(Air Outlet)**

(Refer page 12)

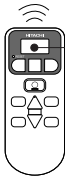

Remote controller

Send out operation signal to the indoor unit. So as to operate the whole unit.
(Refer page 6)

OUTDOOR UNIT

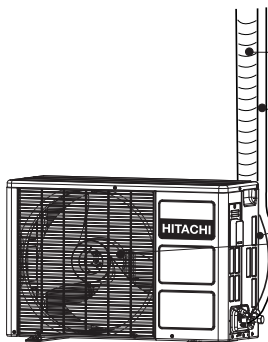

Drain pipe

Condensed water drain to outside.

Connecting cord and insulation pipe for piping

Air inlet (Back side)

Air outlet

MODEL NAME AND DIMENSIONS

MODEL	WIDTH (mm)	HEIGHT (mm)	DEPTH (mm)
RAS-E10CZ	785	248	200
RAC-E10CZ	700	468	258

INDOOR UNIT INDICATORS

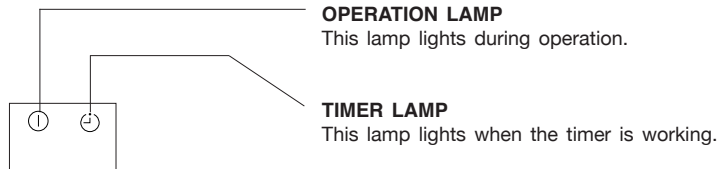

OPERATION INDICATOR

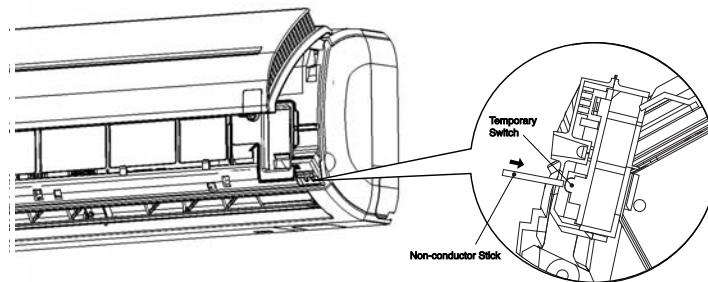

TEMPORARY SWITCH

Use this switch to start and stop when the remote controller does not work. [Use non-conductor stick (example toothpick)]

Normal operation:

- By pressing the temporary switch, operation is done based on current room temperature.
If detected room temperature is more than 27°C, unit will enter cooling mode.
If detected room temperature is 27°C and less, unit will enter dehumidifying mode.
- This judgement also applied when power source is turned OFF and ON again when operation is done using temporary switch.

Force cooling operation: (For servicing purpose only)

- By pressing and hold the temporary switch for more than 5 second, the unit will enter “Force Cooling Operation”. Timer lamp will blink 2 times.
- Press again the temporary switch to cancel the force cooling operation.
- Do not operate in this mode for more than 5 minutes.

* To be conduct by authorised personel only.

NAMES AND FUNCTIONS OF REMOTE CONTROL UNIT

REMOTE CONTROLLER

This controls the operation of the indoor unit. The range of control is about 7 meters. If indoor lighting is controlled electronically, the range of control may be shorter.

This unit can be fixed on a wall using the fixture provided. Before fixing it, make sure the indoor unit can be controlled from the remote controller.

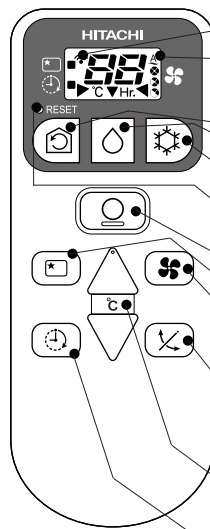

- **Transmission sign**
The transmission sign blinks when a signal is sent.
- **Display**
This indicates the room temperature selected, timer status, function and intensity of circulation selected.
- **CIRCULATION button**
Use this button to set air circulation in the room or start operation.
- **DEHUMIDIFYING button**
Use this button to dehumidify the room or start operation.
- **COOLING button**
Use this button to set cooling mode in the room or start operation.
- **RESET button**
- **STOP button**
Press this button to stop operation only.
- **SLEEP button**
Use this button to set the sleep timer/off timer.
- **FAN SPEED selector**
This determines the fan speed. Every time you press this button, the intensity of circulation will change from Δ (AUTO) to \otimes (HI) to \otimes (MED) to \odot (LOW).
- **AUTO SWING button**
Controls the angle of the horizontal air deflector.
- **TEMPERATURE button**
Use this button to raise or lower the temperature setting. (Keep pressed, and the value will change more quickly.)
- **ON-TIMER button** Select the turn ON time.

	CIRCULATION / START
	DEHUMIDIFY / START
	COOLING / START
	FAN
	FAN SPEED
Δ	AUTO
\otimes	HI
\otimes	MED
\odot	LOW
	SLEEP TIMER
	STOP
	ON TIMER
\times	AUTO SWING

Precautions for Use

- Do not put the remote controller in the following places.
 - In direct sunlight.
 - In the vicinity of a heater.
- Handle the remote controller carefully. Do not drop it on the floor, and protect it from water.
- Once the outdoor unit stops, it will not restart for about 3 minutes (unless you turn the power switch off and on or unplug the power cord and plug it in again). This is to protect the device and does not indicate a failure.
- If you press the FUNCTION selector button during operation, the device may stop for about 3 minutes for protection.

COOLING OPERATION

Use the device for cooling when the outdoor temperature is 21-43°C.
 If indoor humidity is very high (over 80%), some dew may form on the air outlet grille of the indoor unit.

1 Press the (COOLING) button so that the display indicates pointing to button.

Cooling operation starts with a beep.
 The cooling function does not start if the temperature setting is higher than the current room temperature (even though the (OPERATION) lamp lights). The cooling function will start as soon as you set the temperature below the current room temperature.

2 Set the desired FAN SPEED with the (FAN SPEED) button (the display indicates the setting).

- (AUTO) : The FAN SPEED is HI at first and varies to MED or LOW automatically when the preset temperature has been reached.
- (HI) : Economical as the room will become cool quickly.
- (MED) : Fan speed slow.
- (LOW) : Fan speed slower.

3 Set the desired room temperature with the TEMPERATURE button (the display indicates the setting).

The range of 25-28°C is recommended as the room temperature for cooling.
 If the temperature setting is 27°C, the room temperature will be controlled at around 27°C.

The temperature setting and the actual room temperature may vary somehow depending on conditions.



STOP Press the (STOP) button to stop operation.

■ As the settings are stored in memory in the remote controller, you only have to press the (COOLING) button next time.

DEHUMIDIFYING OPERATION

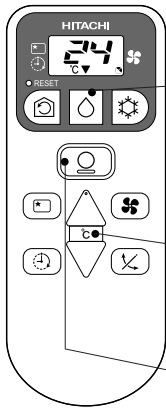
Use the device for dehumidifying when the room temperature is over 16°C.
When it is under 15°C, the dehumidifying function will not work.





1 Press the  (DEHUMIDIFY) button so that the display indicates  pointing to  button.
Dehumidifying operation starts with a beep.
The FAN SPEED is set at LOW automatically.
The FAN SPEED button does not work.

2 Set the desired room temperature with the TEMPERATURE button (the display indicates the setting).



The range of 20-26°C is recommended as the room temperature for dehumidifying.

STOP Press the  (STOP) button to stop operation.

- As the settings are stored in memory in the remote controller, you only have to press the  (DEHUMIDIFY) button next time.



■ Dehumidifying Function

When the room temperature is higher than the temperature setting: The device will dehumidify the room, reducing the room temperature to the preset level.

When the room temperature is lower than the temperature setting: Dehumidifying will be performed at the temperature setting slightly lower than the current room temperature, regardless of the temperature setting. The function will stop (the indoor unit will stop emitting air) as soon as the room temperature becomes lower than the setting temperature. You might feel a bit colder in dehumidifying operation.

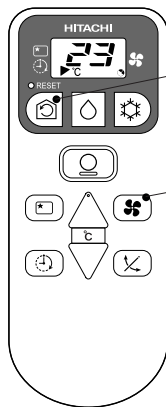
CIRCULATION OPERATION



1 Press the  (CIRCULATION) button so that the display indicates  pointing to  button. Circulating operation starts with a beep.

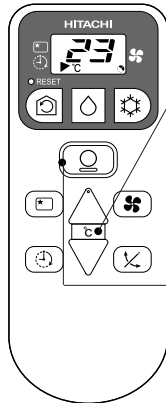

2 Press the FAN SPEED button and select the desired FAN SPEED (the display indicates your choice).

3 Press the temperature control button to set to the desired temperature.

STOP Press the  (STOP) button to stop operation.

■ As the settings are stored in memory in the remote controller, you only have to press the  (CIRCULATION) button next time.

■ Circulation Function

- During circulation operation, compressor will not be running and there is no cooling operation with only indoor fan running.
- When the setting temperature is higher than room temperature, indoor fan will stop running.

HOW TO SET THE SLEEP TIMER/OFF TIMER

Press the  (SLEEP) button, and the display changes as shown below.

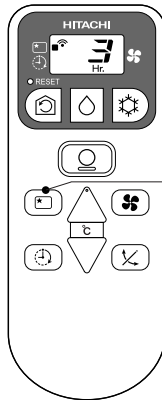

Mode	Indication
Sleep timer	

Sleep Timer: The device will continue working for the designated number of hours and then turn off. Point the signal window of the remote controller toward the indoor unit, and press the SLEEP button. The timer information will be displayed on the remote unit. The TIMER lamp lights with a beep from the indoor unit.

Explanation of the sleep timer

The device will control the FAN SPEED and room temperature automatically so as to be quiet and good for people's health.

NOTE

- You can not set other timer during sleep timer operation.
- After sleep timer time is up and when press sleep button again, the sleep timer will be set as last setting.
- Sleep timer effective only once.

HOW TO SET THE TIMER

ON Timer Reservation

ON TIME setting

- Select the ON TIMER by pressing the  (ON) Button.
- Setting time will change according to the below sequence.

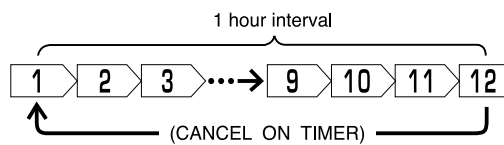

- Operation will start for setting temperature at setting time (The starting time may different depend on the room temperature and set temperature).

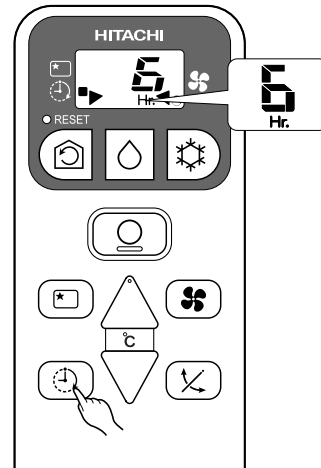

AIR FLOW LOUVERS ADJUSTMENTS

1. Adjusting the left and right air flow directions

Move the vertical air flow louvers as illustrated, to adjust the air flow to flow towards the left or right directions.

2. Adjusting the downward air flow direction.

During the "Dehumidifying" or "Cooling" operating modes, the horizontal air flow louvers are automatically adjusted to suit the air flow angles of each operating mode. The air flow louvers are designed to direct air flow in upward and downward directions. Pressing the automatic air flow control button, these air flow louvers can also be adjusted to any air flow angle of one's choice.

Press the AUTOMATIC AIR FLOW DIRECTION once will activate the horizontal air flow louvers to direct the air flows upwards and downwards. Press the control button again, the horizontal air flow louvers will stop moving and remain fixed at the position at the point when the control button was pressed

During the "Dehumidifying" or "Cooling" operating modes, set the horizontal air flow louvers to move within the range as recommended in the illustration

Adjusting the air flow louvers will direct air flows to assist in reducing the room temperature and to correct any temperature imbalance

During the "Cooling" operating mode, do not adjust the horizontal air flow louvers to swing outside the range as indicated by arrows in the illustration. Do not operate the horizontal air flow louvers in durations longer than it is necessary. Condensate may form and drip along the horizontal air flow louvers.

After stopping the operations of the unit by pressing  control button, the horizontal air flow louvers will move to park at a position that covers up the air outlet vent.

While the automatic air flow direction mode is in operation, any physical adjustment to the horizontal air flow louvers will shift the swing range. However, with no further physical adjustments, the air flow louvers will readjust automatically to the original swing range setting. (Should the louvers could not return to the original swing range setting, stop the operation of the air conditioner unit, remove the power supply plug and re-plug it into the power mains socket and restart the air conditioner unit. This will return the swing range to its original setting)

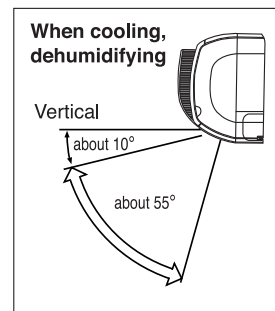
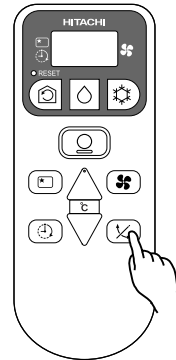
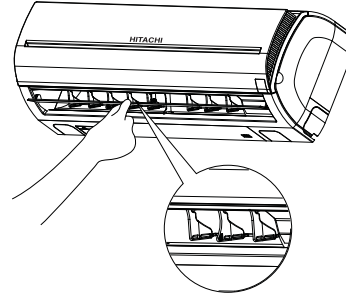

HOW TO EXCHANGE THE BATTERIES IN THE REMOTE CONTROLLER

When using the remote control, there is no response from the air conditioner unit and or the remote control has fading and dim displays, the batteries in the remote control device need to be removed and replaced with new ones

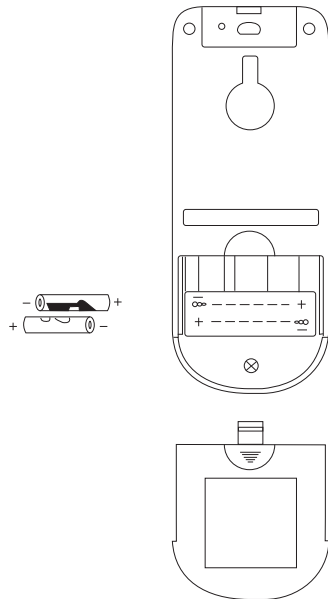

1 Remove the cover as shown in the figure and take out the old batteries.



2 Install the new batteries.
The direction of the batteries should match the marks in the case.

⚠ CAUTION

1. Do not use new and old batteries, or different kinds of batteries together.
2. Take out the batteries when you do not use the remote controller for 2 or 3 months.
3. Use high quality and high performance AAA batteries to avoid short operating life and electrolyte leakages

THE IDEAL WAYS OF OPERATION

Suitable Room Temperature



Warning
Freezing temperature is bad for health and a waste of electric power.

Install curtain or blinds

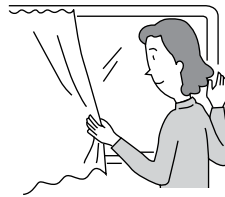

It is possible to reduce heat entering the room through windows.

Ventilation

Caution
Do not close the room for a long period of time. Occasionally open the door and windows to allow the entrance of fresh air.



Effective Usage Of Timer

At night, please use the "OFF or ON timer operation mode", together with your wake up time in the morning. This will enable you to enjoy a comfortable room temperature. Please use the timer effectively.

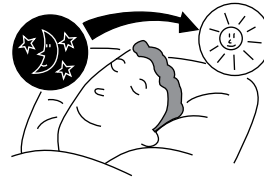

Do Not Forget To Clean The Air Filter

Dusty air filter will reduce the air volume and the cooling efficiency. To prevent from wasting electric energy, please clean the filter every 2 weeks.

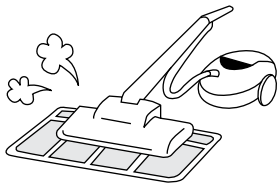

Please Adjust Suitable Temperature For Baby And Children

Please pay attention to the room temperature and air flow direction when operating the unit for baby, children and old folks who have difficulty in movement.

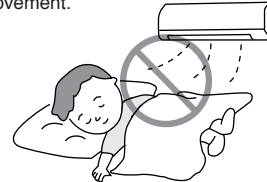

FOR USER'S INFORMATION

ENGLISH

The Air Conditioner And The Heat Source In The Room

⚠ Caution

If the amount of heat in the room is above the cooling capability of the air conditioner (for example: more people entering the room, using heating equipments and etc.), the preset room temperature cannot be achieved.

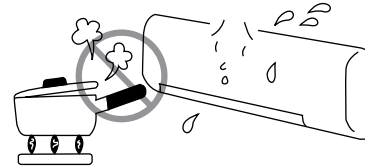

Not Operating For A Long Time

When the indoor unit is not to be used for a long period of time, please switch off the power from the mains. If the power from mains remains "ON", the indoor unit still consumes about 8W in the operation control circuit even if it is in "OFF" mode.

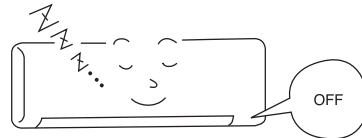

When Lightning Occurs

⚠ Warning

To protect the whole unit during lightning, please stop operating the unit and remove the plug from the socket.

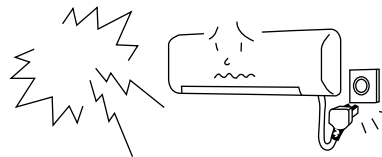

Interference From Electrical Products

⚠ Caution

To avoid noise interference, please place the indoor unit and its remote controller at least 1m away from electrical products.

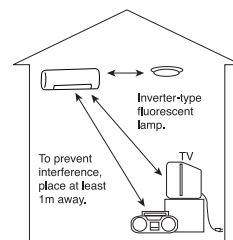



MAINTENANCE

⚠ CAUTION

Before cleaning, stop operation and switch off the power supply.

1. AIR FILTER

Clean the air filter, as it removes dust inside the room. In case the air filter is full of dust, the air flow will decrease and the cooling capacity will be reduced. Further, noise may occur. Be sure to clean the filter following the procedure below.

PROCEDURE

- 1 Open the front panel and remove the filter
 - Gently lift and remove the air cleansing filter from the air filter frame.

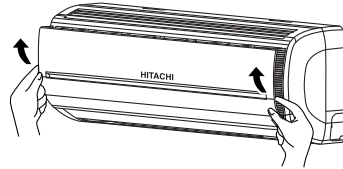

- 2 Vacuum dust from the air filter and air cleansing filter using vacuum cleaner. If there is too much dust, air filter only rinse under running tap water and gently brush it with soft bristle brush. Allow filters to dry in shade.

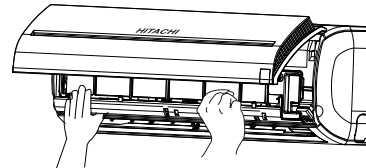

- 3
 - Re-insert the air cleansing filter to the filter frame. Set the filter with "FRONT" mark facing front, and slot them into the original state.
 - After attaching the filters, push the front panel at three arrow portions as shown in figure and close it.

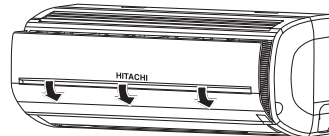

NOTE:

- Air cleansing filter should be cleaned every month or sooner if noticeable loading occurs. When used overtime, it may lose its deodorizing function. For maximum performance, it is recommended to replace it every 1 year depending on application requirements.

⚠ CAUTION

- Do not wash with hot water at more than 40°C. The filter may shrink.
- When washing it, shake off moisture completely and dry it in the shade; do not expose it directly to the sun. The filter may shrink.
- Do not use detergent on the air cleansing filter as some detergent may deteriorate the filter electrostatic performance.

2. CLEANING OF FRONT PANEL

- Remove the front panel and wash with clean water. Wash it with sponge. After using detergent, wash thoroughly with clean water.
- When front panel is not removed, wipe it with a soft dry cloth.
- When it is excessively dirty, wipe with a soft cloth soaked in lukewarm water or neutral detergent. Then wipe thoroughly with a soft dry cloth.
- Wipe the remote controller thoroughly with a soft dry cloth.
- Wipe the water thoroughly.
If water remains at the indicators or signal receiver of indoor unit, it causes trouble.

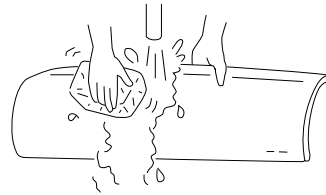

Method of Removing the Front Panel

- Be sure to hold the front panel with both hands to detach and attach it.

Removing the Front Panel

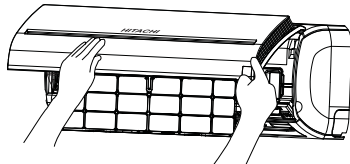

- When the front panel is fully opened with both hands, push the right arm to the inside to release it, and while closing the front panel slightly, pull it out forward.

Attaching the Front Panel

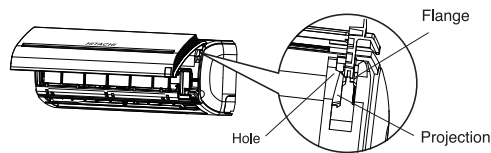

- Move the projections of the left and right arms into the **Flanges** in the unit and securely insert them into the holes.

CAUTION

- Never use hot water (above 40°C), benzine, gasoline, acid, thinner or a brush, because they will damage the plastic surface and the coating.



⚠ CAUTION

- Please use earth line.
Do not place the earth line near water or gas pipes, lightning-conductor, or the earth line of telephone. Improper installation of earth line may cause electric shock.
- A circuit breaker should be installed depending on the mounting site of the unit. Without a circuit breaker, the danger of electric shock exists.



IMPORTANT

The wires in this mains lead are coloured in accordance with the following code:

- Green-and-yellow : Earth
- Blue : Neutral
- Brown : Live

As the colours of the wires in the mains lead of this appliance may not correspond with the coloured markings identifying the terminals in your plug, proceed as follows:

The wire which is coloured green-and-yellow must be connected to the terminal in the plug which is marked with the letter E or by the earth symbol ⚡ or coloured green or green-and-yellow.

The wire which is coloured blue must be connected to the terminal which is marked with the letter N or coloured black.

The wire which is coloured brown must be connected to the terminal which is marked with the letter L or coloured red.

NOTE

If the supply cord is damaged, it must be replaced by the special cord obtainable at authorized service/ parts centers.

⚠ CAUTION

Cleaning and maintenance must be carried out only by qualified service personal. Before cleaning, stop operation and switch off the power supply.

REGULAR INSPECTION

PLEASE CHECK THE FOLLOWING POINTS BY QUALIFIED SERVICE PERSONAL EITHER EVERY HALF YEARLY OR YEARLY. CONTACT YOUR SALES AGENT OR SERVICE SHOP.

1		Is the earth line disconnected or broken?
2		Is the mounting frame seriously affected by rust and is the outdoor unit tilted or unstable?
3		Is the plug of power line firmly plugged into the socket? (Please ensure no loose contact between them).



AFTER SALE SERVICE AND WARRANTY

WHEN ASKING FOR SERVICE, CHECK THE FOLLOWING POINTS.

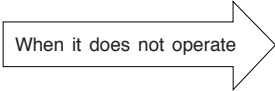
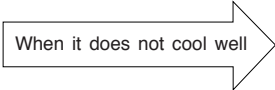
CONDITION	CHECK THE FOLLOWING POINTS
 <p>When it does not operate</p>	<ul style="list-style-type: none"> ● Is the fuse all right? ● Is the voltage extremely high or low? ● Is the circuit breaker "ON"?
 <p>When it does not cool well</p>	<ul style="list-style-type: none"> ● Was the air filter cleaned? ● Does sunlight fall directly on the outdoor unit? ● Is the air flow of the outdoor unit obstructed? ● Are the doors or windows opened, or is there any source of heat in the room? ● Is the set temperature suitable?



Notes

- In quiet or stop operation, the following phenomena may occasionally occur, but they are not abnormal for the operation.
 - (1) Slight flowing noise of refrigerant in the refrigerating cycle.
 - (2) Slight rubbing noise from the fan casing which is cooled and then gradually warmed as operation stops.
- The odor will possibly be emitted from the room air conditioner because the various odor, emitted by smoke, foodstuffs, cosmetics and so on, sticks to it. So the air filter and the evaporator regularly must be cleaned to reduce the odor.

- Please contact your sales agent immediately if the air conditioner still fails to operate normally after the above inspections. Inform your agent of the model of your unit, production number, date of installation. Please also inform him regarding the fault.
- Power supply shall be connected at the rated voltage, otherwise the unit will be broken or could not reach the specified capacity.

