

# HITACHI

Inspire the Next

## SPLIT TYPE AIR CONDITIONER

# INDOOR UNIT/OUTDOOR UNIT

### MODEL

RAS-E10CZJ/RAC-E10CZJ  
RAS-E13CZJ/RAC-E13CZJ

#### OUTDOOR UNIT

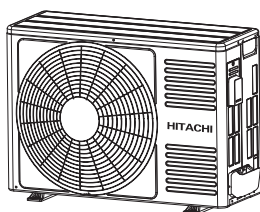

RAC-E10CZJ

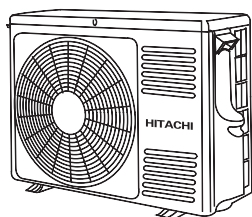

RAC-E13CZJ

#### INDOOR UNIT

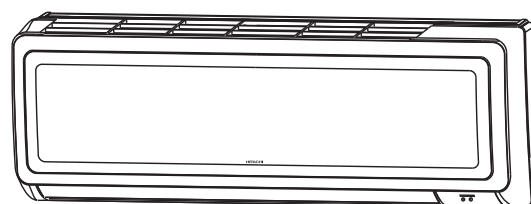

RAS-E10CZJ  
RAS-E13CZJ

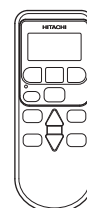



#### Instruction manual

To obtain the best performance, please read this instruction manual completely.







# SAFETY PRECAUTION

- Please read the “Safety Precaution” carefully before operating the unit to ensure correct usage of the unit.
- Pay special attention to signs of “⚠ Warning” and “⚠ Caution”. The “Warning” section contains matters which, if not observed strictly, may cause death or serious injury. The “Caution” section contains matters which may result in serious consequences if not observed properly. Please observe all instructions strictly to ensure safety.
- The signs indicate the following meanings.



 Make sure to connect earth line.	 The sign in the figure indicates prohibition.
 Indicates the instructions that must be followed.	

- Please keep this manual after reading.





## PRECAUTIONS DURING INSTALLATION

 <b>WARNING</b>	<ul style="list-style-type: none"> <li>• Do not reconstruct the unit. Water leakage, fault, short circuit or fire may occur if you reconstruct the unit by yourself.</li> </ul>	
	<ul style="list-style-type: none"> <li>• Please ask your sales agent or qualified technician for the installation of your unit. Water leakage, short circuit or fire may occur if you install the unit by yourself.</li> <li>• Please use earth line. Do not place the earth line near water or gas pipes, lightning-conductor, or the earth line of telephone. Improper installation of earth line may cause electric shock.</li> </ul>	
 <b>CAUTION</b>	<ul style="list-style-type: none"> <li>• A circuit breaker should be installed depending on the mounting site of the unit. Without a circuit breaker, the danger of electric shock exists.</li> </ul>	
	<ul style="list-style-type: none"> <li>• Do not install near location where there is flammable gas. The outdoor unit may catch fire if flammable gas leaks around it.</li> </ul>	
	<ul style="list-style-type: none"> <li>• Please ensure smooth flow of water when installing the drain hose.</li> </ul>	

## PRECAUTIONS DURING SHIFTING OR MAINTENANCE

 <b>W A R N I N G</b>	<ul style="list-style-type: none"> <li>• Should abnormal situation arises (like burning smell), please stop operating the unit and turn off the circuit breaker. Contact your agent. Fault, short circuit or fire may occur if you continue to operate the unit under abnormal situation.</li> </ul>	
	<ul style="list-style-type: none"> <li>• Please contact your agent for maintenance. Improper self maintenance may cause electric shock and fire.</li> </ul>	
	<ul style="list-style-type: none"> <li>• Please contact your agent if you need to remove and reinstall the unit. Electric shock or fire may occur if you remove and reinstall the unit yourself improperly.</li> </ul>	
	<ul style="list-style-type: none"> <li>• If the supply cord is damaged, it must be replaced by the special cord obtainable at authorized service/parts centers.</li> </ul>	

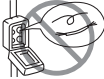
## PRECAUTIONS DURING OPERATION

 <b>W A R N I N G</b>	<ul style="list-style-type: none"> <li>• Avoid an extended period of direct air flow for your health.</li> </ul>	
	 <ul style="list-style-type: none"> <li>• Do not put objects like thin rods into the panel of blower and suction side because the high-speed fan inside may cause danger.</li> </ul>	
	<ul style="list-style-type: none"> <li>• Do not use any conductor as fuse wire, this could cause fatal accident.</li> </ul>	
	 <ul style="list-style-type: none"> <li>• During thunder storm, disconnect and turn off the circuit breaker.</li> </ul>	

## PRECAUTIONS DURING OPERATION

- Do not connect the power cable with an extension cable or do not plug too many leads of the other electric appliance into the socket where this cable is plugged. In addition, wire the cable with some allowances to prevent the cable from stretching. Not doing so will cause an electrical shock, heat generation or fire.



- Do not bundle the power cable, pull it, put something on it, heat it, process it, or put it between things. Breakage of the power cable may result. Use of a damaged cable may cause an electrical shock or a fire.



- The product shall be operated under the manufacturer specification and not for any other intended use.



- Do not attempt to operate the unit with wet hands, this could cause fatal accident.

- When operating the unit with burning equipments, regularly ventilate the room to avoid oxygen insufficiency.

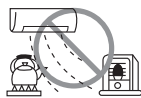
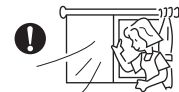

- Do not direct the cool air coming out from the air-conditioner panel to face household heating apparatus as this may affect the working of apparatus such as the electric kettle, oven etc.

- Please ensure that outdoor mounting frame is always stable, firm and without defect. If not, the outdoor unit may collapse and cause danger.



- Do not splash or direct water to the body of the unit when cleaning it as this may cause short circuit.

- Do not use any aerosol or hair sprays near the indoor unit. This chemical can adhere on heat exchanger fin and blocked the evaporation water flow to drain pan. The water will drop on tangential fan and cause water splashing out from indoor unit.



- Please switch off the unit and turn off the circuit breaker during cleaning, the high-speed fan inside the unit may cause danger.



- Turn off the circuit breaker if the unit is not to be operated for a long period.



- Do not climb on the outdoor unit or put objects on it.

- Do not put water container (like vase) on the indoor unit to avoid water dripping into the unit. Dripping water will damage the insulator inside the unit and causes short-circuit.



- Do not place plants directly under the air flow as it is bad for the plants.

- When operating the unit with the door and windows opened, (the room humidity is always above 80%) and with the air deflector facing down or moving automatically for a long period of time, water will condense on the air deflector and drips down occasionally. This will wet your furniture. Therefore, do not operate under such condition for a long time.

- If the amount of heat in the room is above the cooling or heating capability of the unit (for example: more people entering the room, using heating equipments and etc.), the preset room temperature cannot be achieved.

- This appliance is not intended for use by young children unless they have been adequately supervised by a responsible person to ensure that they can use the appliance safely.
- Young children should be supervised to ensure that they do not play with the appliance.



W  
A  
R  
N  
I  
N  
G

# NAMES AND FUNCTIONS OF EACH PART

## INDOOR UNIT

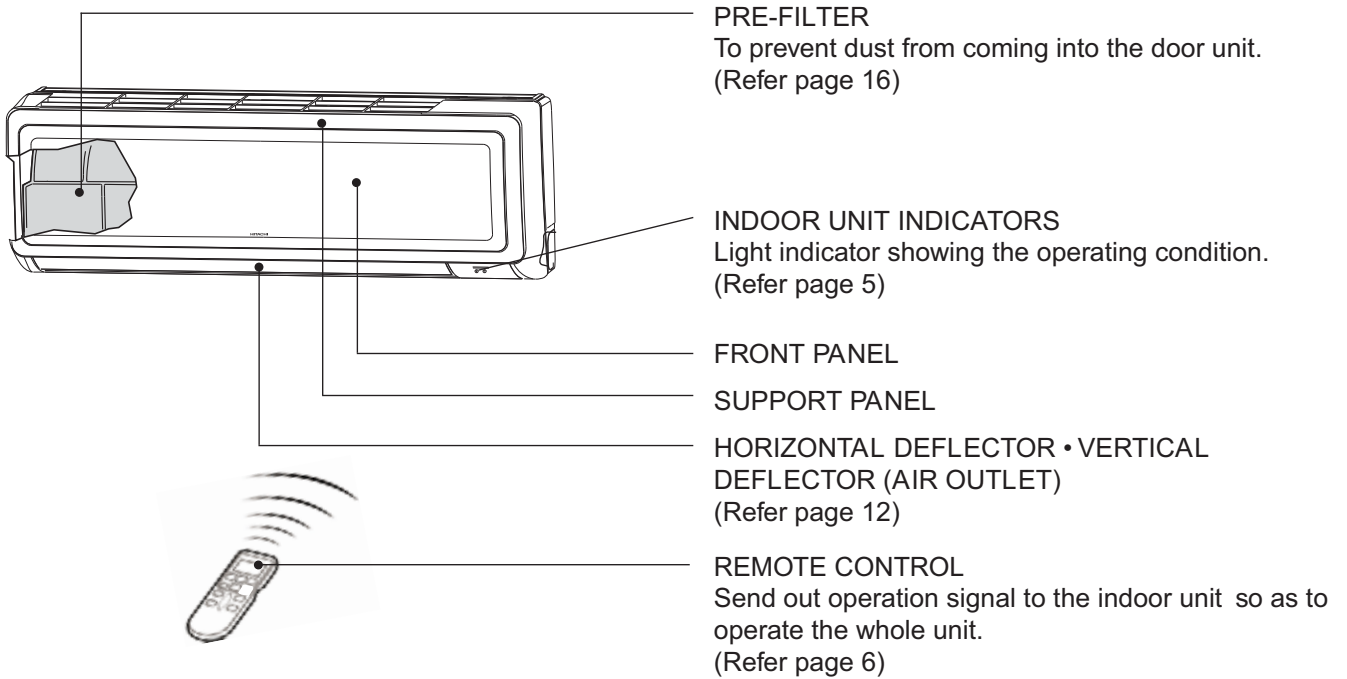

## OUTDOOR UNIT

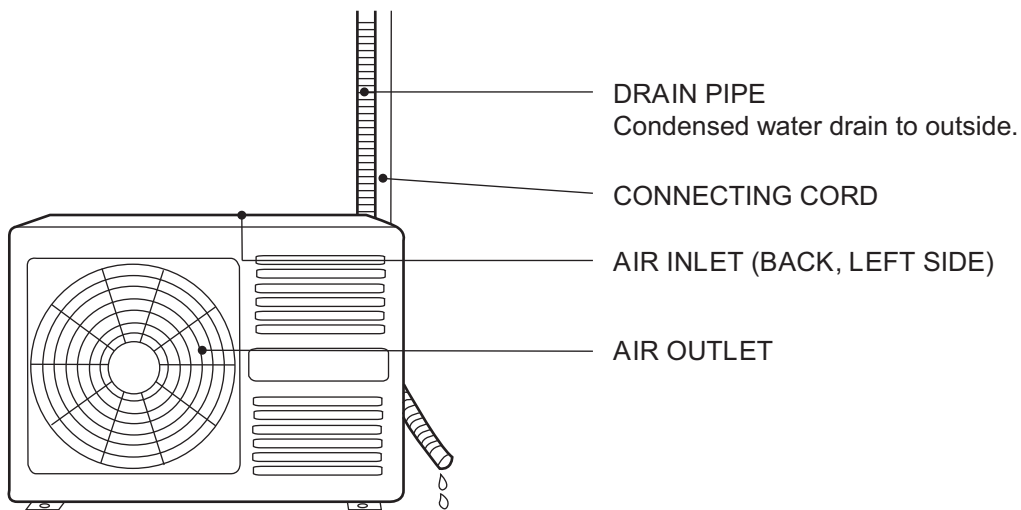

## MODEL NAME AND DIMENSIONS

MODEL	WIDTH(mm)	HEIGHT(mm)	DEPTH(mm)
RAS-E10CZJ, RAS-E13CZJ	780	280	220
RAC-E10CZJ	700(+59)	505	258(+48)
RAC-E13CZJ	750(+91)	548	288(+47)

## RECEIVABLE INDICATOR FUNCTIONS

---

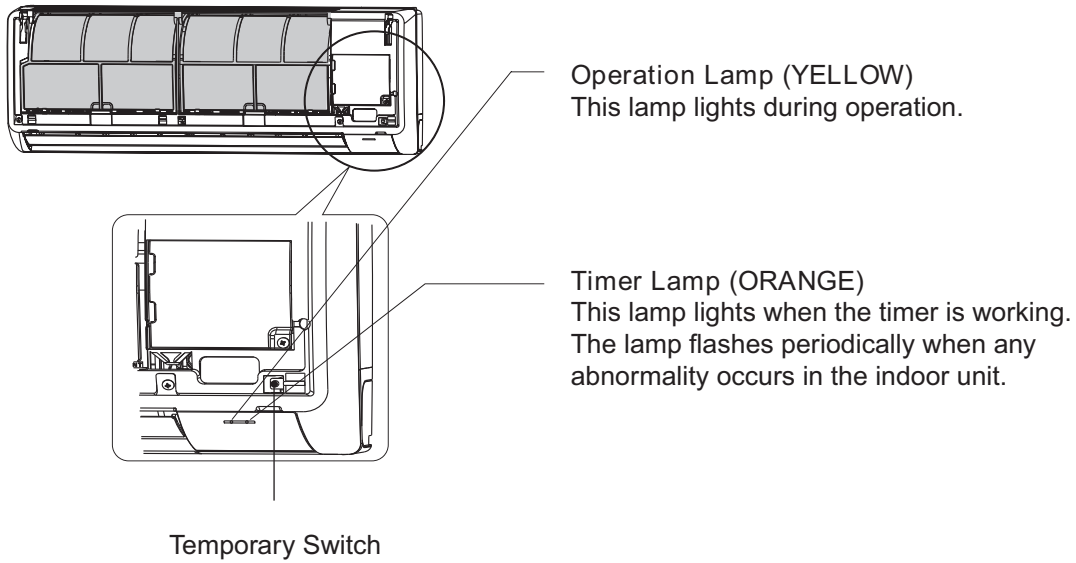

## OPERATION INDICATOR

---

### TEMPORARY SWITCH

When the remote control device is not functioning, use the Temporary Switch mode

- (1) When the Temporary Switch is pressed, the unit will operate as per the previous setting.
- (2) Press the Temporary Switch a second time will stop the operations of the air conditioner unit.

### AUTO RESTART FUNCTION

In the event of power failure, the air conditioner will restart automatically.

In the event of power failure during TIMER operation, the timer will be reset and the unit will begin or stop operating under a new timer setting.

# NAMES AND FUNCTIONS OF REMOTE CONTROL UNIT

## REMOTE CONTROLLER

This controls the operation of the indoor unit. Signal range to reach indoor unit is about 7 meters.

This unit can be fixed on a wall using the fixture provided. Before fixing it, make sure the indoor unit can be controlled from the remote controller.

- **Transmission sign**  
The transmission sign blinks when a signal is sent.
- **Display**  
This indicates the room temperature selected, current time, timer status, function and intensity of circulation selected.
- **AIR CIRCULATION button**  
Use this button to set air circulation in the room or start operation.
- **DEHUMIDIFYING button**  
Use this button to reduce water quantity in the room or start operation.
- **COOLING button**  
Use this button to set cooling mode in the room or start operation.
- **RESET button**
- **STOP button**  
Press this button to stop operation only.
- **SLEEP button**  
Use this button to set the sleep timer.
- **FAN SPEED selector**  
This determines the fan speed. Each time you press this button, the intensity of circulation will change from Ⓐ (AUTO) to Ⓓ (HI) to Ⓒ (MED) to Ⓖ (LOW) (during the ☉ (AIR CIRCULATION) mode, from Ⓓ HI to Ⓒ MED to Ⓖ LOW).
- **AUTO SWING button**  
Controls the angle of the horizontal air deflector and to turn off filter lamp.
- **TEMPERATURE button**  
Use this button to raise or lower the temperature setting. (Keep pressed, and the value will change more quickly.)
- **OFF-TIMER button** Select the turn OFF time.
- **ON-TIMER button** Select the turn ON time.

	CIRCULATION / START
	DEHUMIDIFY / START
	COOLING / START
	FAN
	FAN SPEED LOW MED HI
	SLEEP TIMER
	STOP
	TIMER SELECTOR ON TIMER OFF TIMER
	AUTO SWING

### Precautions for Use

- Do not put the remote controller in the following places.
  - In direct sunlight.
  - In the vicinity of a heater.
- Handle the remote controller carefully. Do not drop it on the floor, and protect it from water.
- Once the outdoor unit stops, it will not restart for about 3 minutes (unless you turn the power switch off and on or unplug the power cord and plug it in again).  
This is to protect the device and does not indicate a failure.

# COOLING OPERATION

Use the device for cooling when the outdoor temperature is 21-43°C.  
If humidity is very high (over 80°C) indoors, some dew may form on the air outlet grille of the indoor unit.

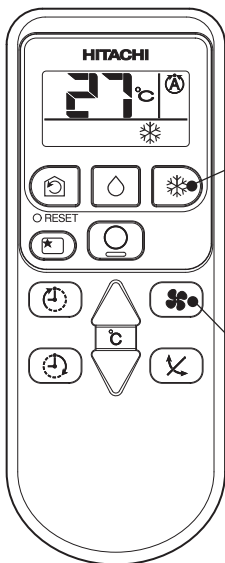

1

Press the button so that the display indicates (COOLING).  
Cooling operation starts with a beep.  
The cooling function does not start if the temperature setting is higher than the current room temperature (even though the (OPERATION) lamp lights). The cooling function will start as soon as you set the temperature below the current room temperature.

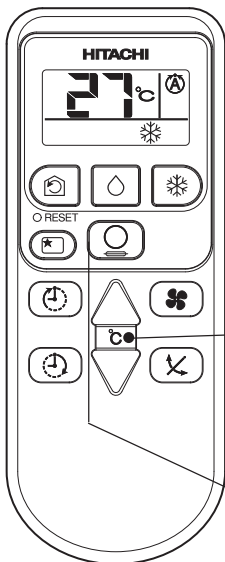

2

Set the desired FAN SPEED with the (FAN SPEED) button (the display indicates the setting).

- (AUTO) : The FAN SPEED is HI at first and varies to MED or LOW automatically when the preset temperature has been reached.
- (HI) : Hi fan speed mode.
- (MED) : Medium fan speed mode.
- (LOW) : Low fan speed mode.

3

Set the desired room temperature with the TEMPERATURE button (the display indicates the setting).



The range of 25-28°C is recommended as the room temperature for cooling.  
If the temperature setting is 27°C, the room temperature will be controlled at around 27°C.

The temperature setting and the actual room temperature may vary somewhat depending on conditions.

STOP

Press the (STOP) button to stop operation.

- As the settings are stored in memory in the remote controller, you only have to press the (COOLING) button to repeat the same settings next time.

# DEHUMIDIFYING OPERATION

Use the device for dehumidifying when the room temperature is over 16°C.  
When it is under 15°C, the dehumidifying function will not work.

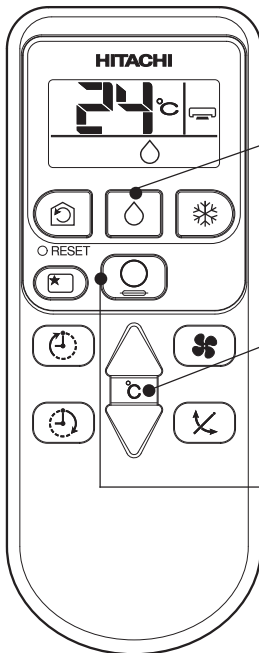

**1** Press the  (DEHUMIDIFY) button.  
Dehumidifying operation starts with a beep.  
The FAN SPEED is set at LOW automatically.  
The FAN SPEED button does not work.

**2** Set the desired room temperature with the TEMPERATURE button (the display indicates the setting).  
 The range of 20-26°C is recommended as the room temperature for dehumidifying.

**STOP** Press the  (STOP) button to stop operation.

- As the settings are stored in memory in the remote controller, you only have to press the  (DEHUMIDIFY) button to repeat the same settings next time.

## ■ Dehumidifying Function

When the room temperature is higher than the temperature setting: The device will dehumidify the room, reducing the room temperature to the preset level.  
When the room temperature is lower than the temperature setting: Dehumidifying will be performed at the temperature setting slightly lower than the current room temperature, regardless of the temperature setting. The function will stop (the indoor unit will stop emitting air) as soon as the room temperature becomes lower than the setting temperature. You might feel a bit colder in dehumidifying operation.

# CIRCULATION OPERATION

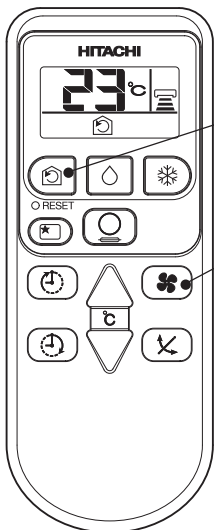

1

Press the  button so that the display indicates (CIRCULATE). Circulating operation starts with a beep.

2

Press the FAN SPEED button and select the desired FAN SPEED (the display indicates your choice).

3

Press the temperature control button to set to the desired temperature.

STOP

Press the  (STOP) button to stop operation.

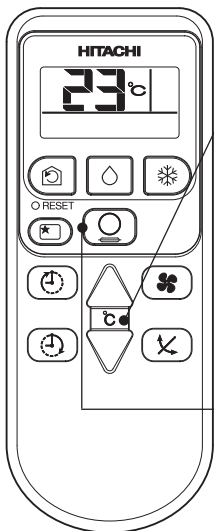

- As the settings are stored in memory in the remote controller, you only have to press the  (CIRCULATION) button to repeat the same settings next time.

## ■ Circulation Function

- During circulation operation, compressor does not run and there is no cooling operation with only indoor fan running.
- When the setting temperature is higher than room temperature, indoor fan will stop running.

# HOW TO SET THE SLEEP TIMER

Press the  (SLEEP) button, and the display changes as shown below.

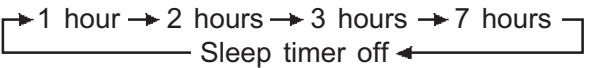
Mode	Indication
Sleep timer	

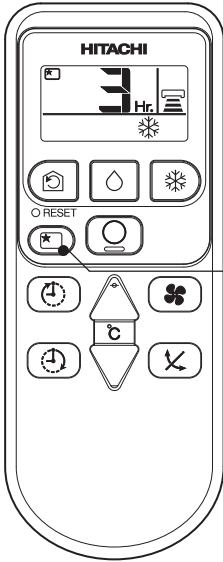

SLEEP

Sleep Timer: The device will continue working for the designated number of hours and then turn off.

Point the signal window of the remote controller toward the indoor unit, and press the SLEEP button.

The timer information will be displayed on the remote controller.

The TIMER lamp lights with a beep from the indoor unit.



## Explanation of the sleep timer

The device will control the FAN SPEED and room temperature automatically so as to be quiet and good for people's health.

You can set the sleep timer to turn off after 1, 2, 3 or 7 hours. The FAN SPEED and room temperature will be controlled as shown below.

### Operation with the sleep timer

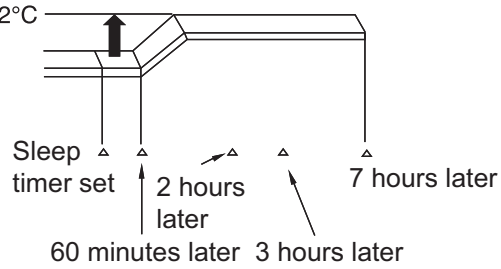
Function	Operation
Cooling "❄️" and dehumidifying "💧"	The room temperature will be controlled 2°C above the setting temperature and the FAN SPEED will be set to LOW setting 60 minutes after the setting of the sleep timer. 
Fan "🌀"	The settings of room temperature and circulation are varied.

# HOW TO SET THE TIMER

- ON Timer and OFF Timer are available.

## OFF Timer Reservation

### OFF TIME setting

- Select the OFF TIME by pressing the  (OFF) Button.
- Setting time will change according to the below sequence when you press the button.

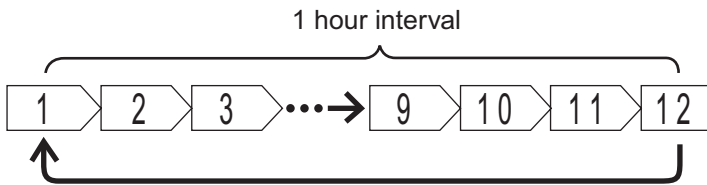

- Operation stop at setting time

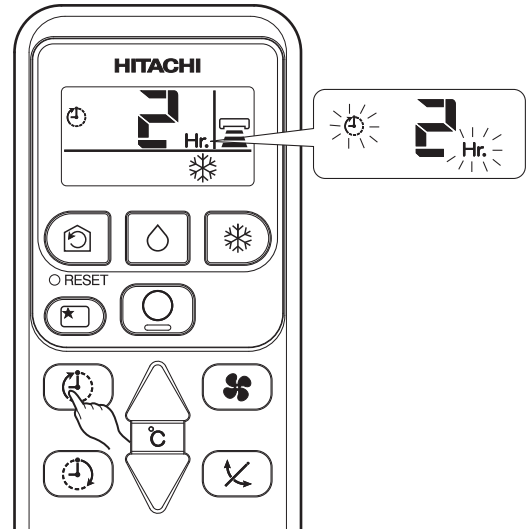

## ON Timer Reservation

### ON TIME setting

- Select the ON TIMER by pressing the  (ON) Button.
- Setting time will change according to the below sequence.

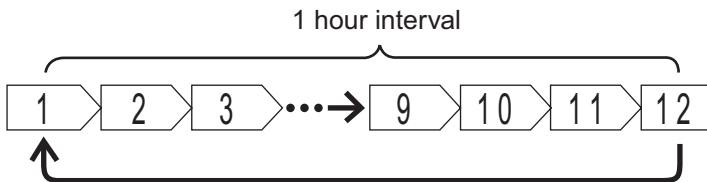

- Operation will start for setting temperature at setting time (The starting time may different depend on the room temperature and set temperature).

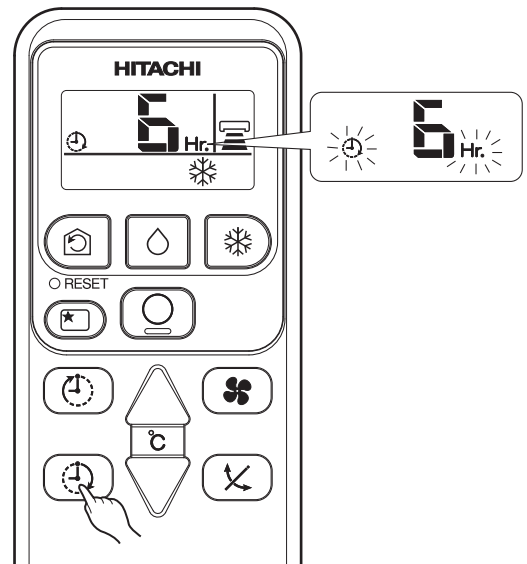

# AIR FLOW LOUVERS ADJUSTMENTS

- 1 Adjustment of the conditioned air in the upward and downward directions.  
The horizontal air deflector is automatically set to the proper angle suitable for each operation. The deflector can be swung up and down continuously and also set to the desired angle using the “ (AUTO SWING)” button.

- If the “ (AUTO SWING)” button is pressed once, the horizontal air deflector swings up and down. If the button is pressed again, the deflector stops in its current position. Several seconds (about 6 seconds) may be required before the deflector starts to move.
- Use the horizontal air deflector within the adjusting range shown on the right.
- When the operation is stopped, the horizontal air deflector moves and stops at the position where the air outlet closes.

**▲ CAUTION**

- In “Cooling” operation, do not keep the horizontal air deflector swinging for a long time. Some dew may form on the horizontal air deflector and dew may drop.

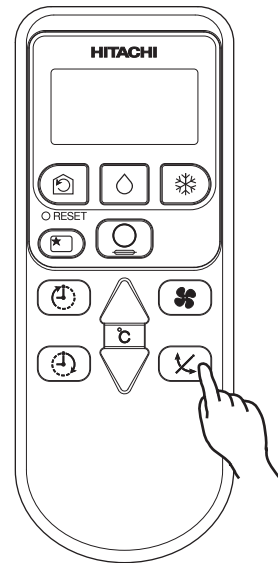

- 2 Adjustment of the conditioned air to the left and right.  
Hold the vertical air deflector as shown in the figure and adjust the conditioned air to the left and right.

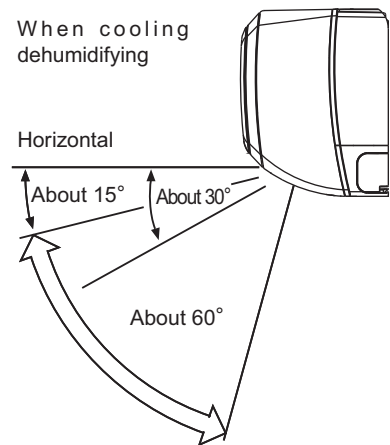
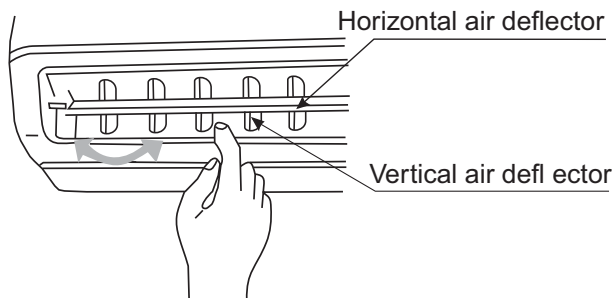

# HOW TO EXCHANGE THE BATTERIES IN THE REMOTE CONTROLLER

When using the remote controller, if there is no response from the air conditioner unit and or the remote control has fading and dim displays, the batteries in the remote control device need to be removed and replaced with new ones

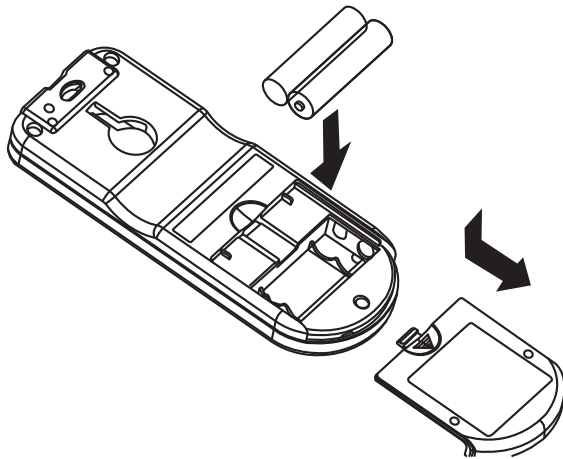

**1** Remove the cover as shown in the figure and take out the old batteries.

=

**2** Install the new batteries. The direction of the batteries should match the marks in the case.



## CAUTION

1. Do not use new and old batteries, or different kinds of batteries together.
2. Take out the batteries when you do not use the remote controller for 2 or 3 months.
3. Use high quality and high performance AAA batteries to avoid short operating life and electrolyte leakages.

## NOTE

1. Remove the air cleansing filters (2) from the front cover, gently press both sides of the air cleansing frame to park it securely at the hooks (six places) and reattach the filters with frame to the front cover
2. The cooling capacity is slightly weakened when the air cleansing frames are used.
3. Air cleansing frames can be used for 20 times. Vacuum cleaner and clean water can be used when cleaning the filters. Please contact the sales agent when you want to renew it.

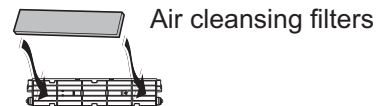
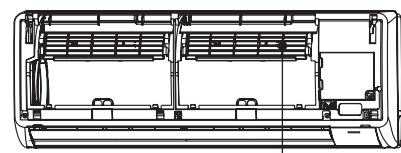



## THE IDEAL WAYS OF OPERATION

### Suitable Room Temperature

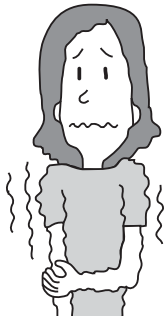

**Warning**  
Freezing temperature is bad for health and a waste of electric power.

### Install curtain or blinds

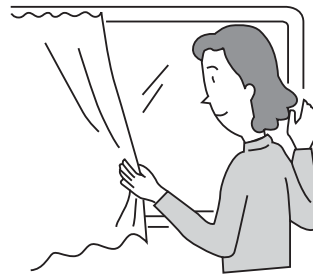

It is possible to reduce heat entering the room through windows.

### Ventilation

**Caution**  
Do not close the room for a long period of time. Occasionally open the door and windows to allow the entrance of fresh air.



### Effective Usage Of Timer

At night, please use the " sleep timer operation mode" , together with your wake up time in the morning. This will enable you to enjoy a comfortable room temperature. Please use the timer effectively.

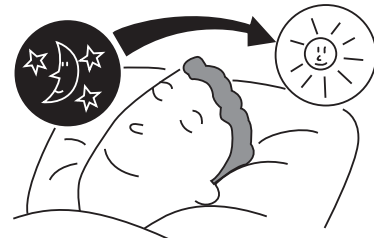

### Do Not Forget To Clean Pre-filter

Dusty Pre-filter will reduce the air volume and the cooling efficiency. To prevent from wasting electric energy, please clean the filter every 2 weeks.

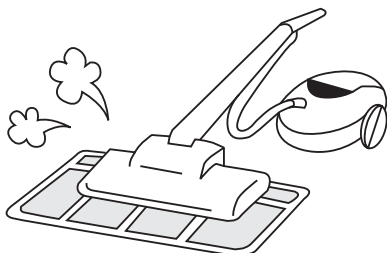

### Please Adjust Suitable Temperature For Baby And Children

Please pay attention to the room temperature and air flow direction when operating the unit for baby, children and old folks who have difficulty in movement.  
(The ideal temperature difference between outdoor and indoor is about  $\pm 5^{\circ}\text{C}$ ).

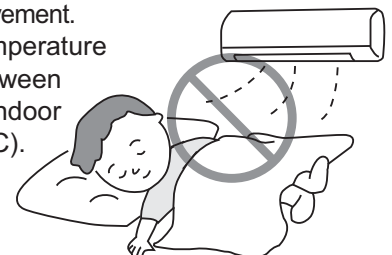



## FOR USER'S INFORMATION

### The Air Conditioner And The Heat Source In The Room

#### Caution

If the amount of heat in the room is above the cooling capability of the air conditioner (for example: more people entering the room, using heating equipments and etc.), the preset room temperature cannot be achieved.

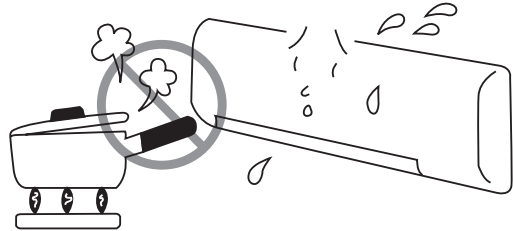

### Not Operating For A Long Time

When the indoor unit is not to be used for a long period of time, please pull out the power plug. Or the indoor unit still consumes about 3W in the operation control circuit even if it is in "OFF" mode.

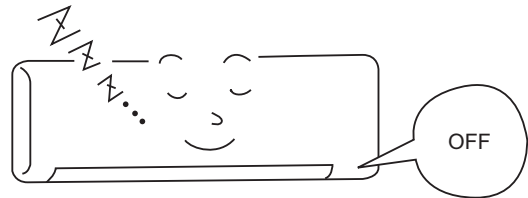

### When Lightning Occurs

#### Warning

To protect the whole unit during lightning, please stop operating the unit and remove the plug from the socket.

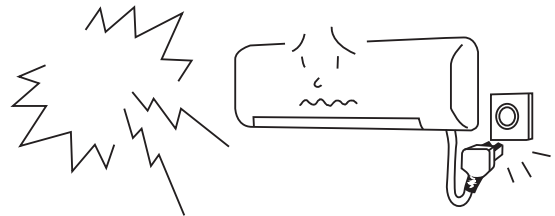

### Interference From Electrical Products

#### Caution

To avoid noise interference, please place the indoor unit and its remote controller at least 1m away from electrical products.

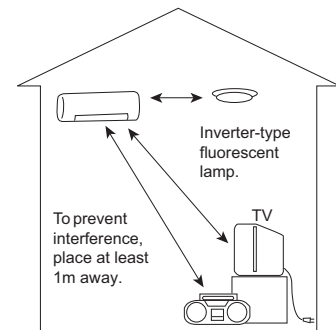

# MAINTENANCE OF THE UNITS

## ⚠ CAUTION

Ensure that the unit is not in operation and all power supply has been disconnected before cleaning the units.

### Pre-filter

Pre-filter are installed to remove the indoor dust particles hence they should be kept clean at all times. They should be cleaned at each machine operation cycle of approximately 100 hours. Excessive dust collected at Pre-filter will block the air flow , reduce the cooling capability and could produce noise. Therefore the Pre-filter should be cleaned as per instructions given below:

### Cleaning Instructions

#### (1) Removing the Pre-filter

- While holding both edges of the front panel, open up and lift the front panel and push in to park at the secured position

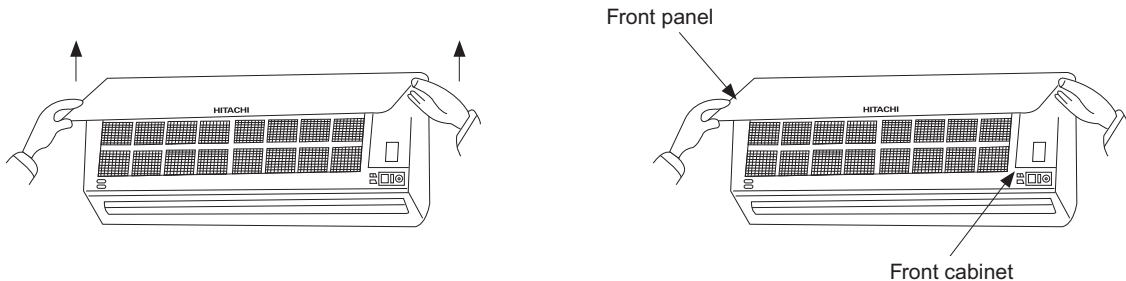

- Slightly lift up the Pre-filter, release the latch clips [2 places] located at the bottom of the front cabinet and move the Pre-filter downwards to remove it from the unit
- (2) Use a vacuum cleaner to vacuum clean the dust accumulated at the Pre-filter . If the accumulated dust is too much to be removed by vacuum cleaning, apply mild detergent and flush the dust from the Pre-filter with water. After thorough rinsing, leave the Pre-filter at a cool shaded place to dry.
  - (3) Re-install the Pre-filter to its original position (With "FRONT" marker facing front). Slightly lift up the opened front panel and close it by returning it to its original position
  - (4) Each year before using the air conditioner unit, clean the heat exchanger (evaporator) with a fine soft brush or a vacuum cleaner and take care to avoid damaging the evaporator fins

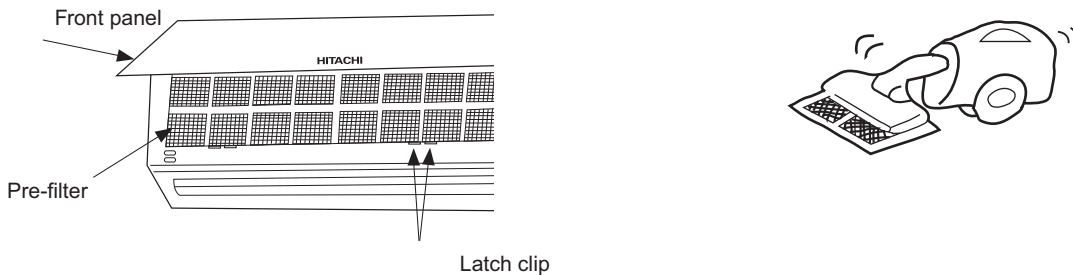

## ⚠ CAUTION

- Do not use hot water (40° C and above) to rinse the Pre-filter, otherwise the screen will warp and get distorted. After rinsing, shake the Pre-filter to rid off all remaining water droplets and place it at a cool shaded place to dry. Avoid placing the Pre-filter under direct sunlight, otherwise the screen will warp and get distorted.  
Do not operate the air conditioner unit without the Pre-filter installed, otherwise the ingress of dust into the air conditioner unit will cause breakdowns.

## CLEANING THE FRONT PANEL

1. Front panel can easily get dirty. Use a soft cloth to wipe it.
2. If the front panel is excessively dirty, wipe the front panel with a soft cloth either wet with warm water or containing a mild detergent after which, wipe dry the front panel with a soft dry cloth.
3. Do not use hot water (50°C and above), volatile liquid, gasoline, acid, diluting agents or brushes to clean the front panel as they could damage the plastic finishing and paintwork of the front panel.

 **CAUTION**  
Please disconnect the power plug before cleaning the front panel.

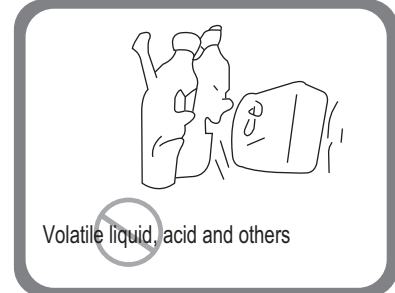
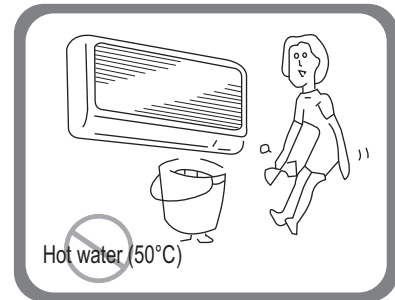

## TROUBLE SHOOTING THE UNIT BEFORE CONTACTING SERVICE STAFF TO CHECK AND RECTIFY

The air conditioner unit is not operating.

- Check whether the power supply plug is properly plugged in.

Abnormal air conditioning effects.

1. Is the Pre-filter clogged with dust and dirt?
2. Is the outdoor unit is located in direct sunlight?
3. Is there any blockage to the air flow of both the indoor and outdoor units?
4. Are the doors and windows being left opened or is there any heat source inside the room?
5. Is the temperature setting appropriate?

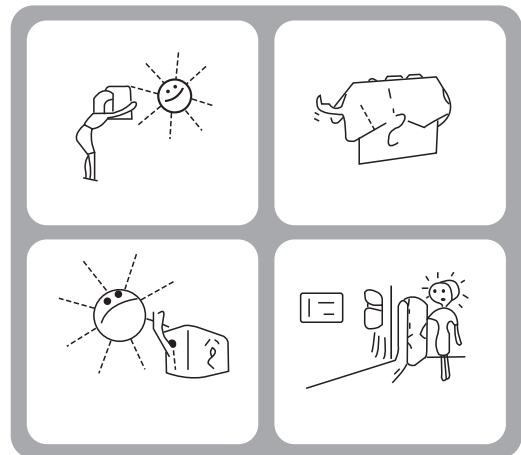



## AFTER SALE SERVICE AND WARRANTY

**WHEN ASKING FOR SERVICE, CHECK THE FOLLOWING POINTS.**

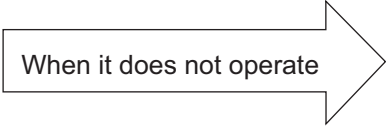
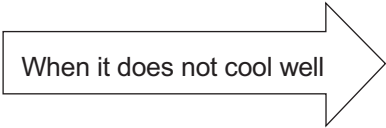
CONDITION	CHECK THE FOLLOWING POINTS
 <p>When it does not operate</p>	<ul style="list-style-type: none"> <li>• Is the fuse all right?</li> <li>• Is the voltage extremely high or low?</li> <li>• Is the circuit breaker "ON"?</li> </ul>
 <p>When it does not cool well</p>	<ul style="list-style-type: none"> <li>• Is the air filter blocked with dust?</li> <li>• Does sunlight fall directly on the outdoor unit?</li> <li>• Is the air flow of the outdoor unit obstructed?</li> <li>• Are the doors or windows opened, or is there any source of heat in the room?</li> <li>• Is the set temperature suitable?</li> </ul>



### Notes

- In quiet or stop operation, the following phenomena may occasionally occur, but they are not abnormal for the operation.
  - (1) Slight flowing noise of refrigerant in the refrigerating cycle.
  - (2) Slight rubbing noise from the fan casing which is cooled and then gradually warmed as operation stops.
- The odor will possibly be emitted from the room air conditioner because the various odor, emitted by smoke, foodstuffs, cosmetics and so on, sticks to it. So please clean the air filter and the evaporator regularly to reduce the odor.

- Please contact your sales agent immediately if the air conditioner still fails to operate normally after the above inspections. Inform your agent of the model of your unit, production number, date of installation. Please also inform him regarding the fault.
- Power supply shall be connected at the rated voltage, otherwise the unit will be broken or could not reach the specified capacity.



A series of horizontal dashed lines for writing.

