

**HITACHI**  
Inspire the Next

**HITACHI SPLIT-UNIT AIR CONDITIONER  
INSTALLATION MANUAL**

**Indoor Unit**  
RAS-S10CY  
RAS-S115CY  
RAS-S13CY

**Outdoor Unit**  
RAC-S10CY  
RAC-S115CY  
RAC-S13CY

- Carefully read through the procedures of proper installation before starting installation work.
- The sales agent should inform customers regarding the correct operation of installation.

**Tools Needed For Installation Work**

- $\oplus \ominus$  Screwdriver • Measuring Tape • Knife
- Saw •  $\phi$  65mm Power Drill • Allen Key ( $\text{I} \text{O}$  4mm)
- Wrench (14, 17, 19, 22mm)
- Gas Leakage Detector • Pipe Cutter
- Plastic Tape • Pliers • Flare Tool

**SAFETY PRECAUTION**

- Read the safety precautions carefully before operating the unit.
  - The contents of this section are vital to ensure safety. Please pay special attention to the following sign.
    - WARNING** ..... Incorrect methods of installation may cause death or serious injury.
    - CAUTION** ..... Improper installation may result in serious consequence.
- Be sure that the unit operates in proper condition after installation. Explain to customer the proper way of operating the unit as described in the user's guide.

**WARNING**

- Please request your sales agent or qualified technician to install your unit. Water leakage, short circuit or fire may occur if you do the installation work yourself.
- Please observe the instructions stated in the installation manual during the process of installation. Improper installation may cause water leakage, electric shock and fire.
- Make sure that the units are mounted at locations which are able to provide full support to the weight of the units. If not, the units may collapse and impose danger.
- Observe the rules and regulations of the electrical installation and the methods described in the installation manual when dealing with the electrical work. Use wire which is specified for the air conditioner. A short circuit and fire may occur due to the use of low quality wire or improper work.
- Be sure to use the specified wire for connecting the indoor and outdoor units. Please ensure that the connections are tight after the conductors of the wire are inserted into the terminals. Improper insertion and loose contact may cause over-heating and fire.
- Please use the specified components for installation work. Otherwise, the units may collapse or water leakage, electric shock and fire may occur.
- Do not mix any coolant other than R-22 into the cooling circulation path when mounting or shifting the unit. If it is mixed with air, the high pressure in the circulation path will rise and this may result in broken copper pipes or faults.

**CAUTION**

- Be sure to use the earth line. Do not place earth line near gas or water pipes, lightning conductor and the earth line of telephone. Improper earthing may cause electric shocks.
- A circuit breaker should be installed depending on the mounting size of the unit. Without a circuit breaker, the danger of electric shock exists.
- Do not install the unit near a location where there is flammable gas. The outdoor unit may catch fire if flammable gas leaks around it.
- Please ensure smooth flow of water when installing the drain hose.

**THE CHOICE OF MOUNTING SITE** (Please note the following matters and obtain permission from customer before installation).

- INDOOR UNIT**
  - WARNING**
    - The unit should be mounted at stable, non-vibratory location which can provide full support to the unit.
  - CAUTION**
    - No nearby heat source and no obstruction near the air outlet is allowed.
    - The clearance distances from top, right and left are specified in figure below.
    - The location must be convenient for water drainage and pipe connection with the Outdoor unit.
    - To avoid interference from noise please place the unit and its remote controller at least 1m from the radio, television and inverter type fluorescent lamp.
    - To avoid any error in signal transmission from the remote controller, please put the controller far away from high-frequency machines and high-power wireless systems.
    - The installation height of indoor unit must be 2.3m or more in a non public area.
- OUTDOOR UNIT**
  - WARNING**
    - The outdoor unit must be mounted at a location which can support heavy weight. Otherwise, noise and vibration will increase.
  - CAUTION**
    - Do not expose the unit under direct sunshine or rain. Besides, ventilation must be good and clear of obstruction.
    - The air blown out of the unit should not point directly to animals or plants.
    - The clearances of the unit from top, left, right and front are specified in figure below. At least three of the above sides must be open air.
    - Be sure that the hot air blown out of the unit and noise do not disturb the neighbourhood.
    - Do not install at a location where there is flammable gas, steam, oil and smoke.
    - The location must be convenient for water drainage.
    - Place the outdoor unit and its connection wire at least 1m away from the antenna or signal line of television, radio or telephone. This is to avoid noise interference.

**Names of Indoor Components**

No.	Component's Name	Qty
①	Mounting Plate	1
②	Screw for Mounting Plate (4.1 x 32)	6
③	Holder for Remote Controller	1
④	AAA Size Battery	2
⑤	Screw for holder of Remote Controller (3.1 x 16)	2
⑥	Remote Controller	1
⑦	Purifying Filter	1
⑧	Hole cover sticker	1

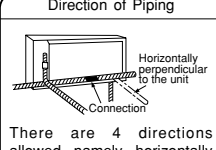
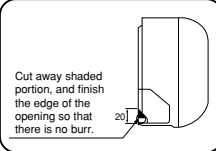
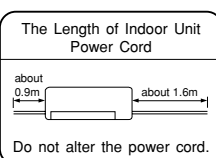

**Figure showing the Installation of Indoor and Outdoor Unit.**

- CAUTION**  
In case the pipe length is more than 8m, add refrigerant R22 at 15 gram per every meter exceeds. However, pipe length shall not exceed 15m.

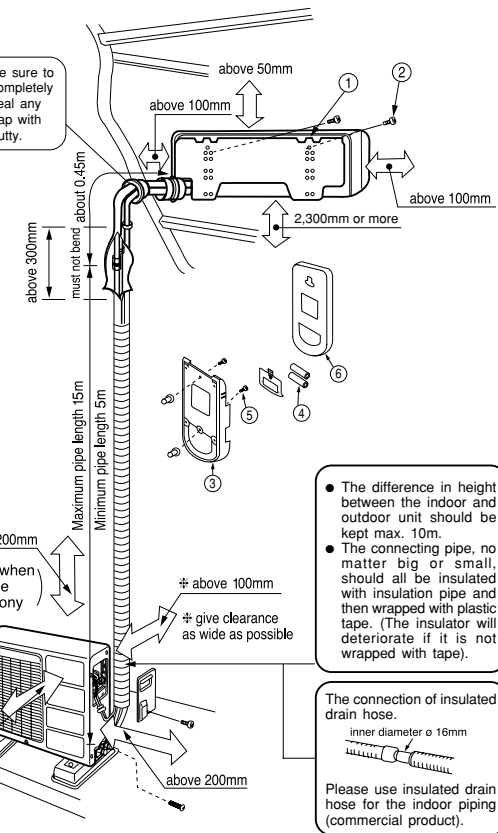

- The difference in height between the indoor and outdoor unit should be kept max. 10m.
- The connecting pipe, no matter big or small, should all be insulated with insulation pipe and then wrapped with plastic tape. (The insulator will deteriorate if it is not wrapped with tape).

The connection of insulated drain hose:  
inner diameter  $\phi$  16mm  
Please use insulated drain hose for the indoor piping (commercial product).

**1 Installation of Hanger, Wall Penetration and Installation of Protection Pipe**

**CAUTION**

- The draining of the water container inside the indoor unit can be done from the left. Therefore the hanger must be fixed horizontally or slightly tilted towards the side of drain hose. Otherwise, condensed water may overflow the water container.

**Direct Mounting On The Wall**

- Please use hidden beams in the wall to hold the hanger.

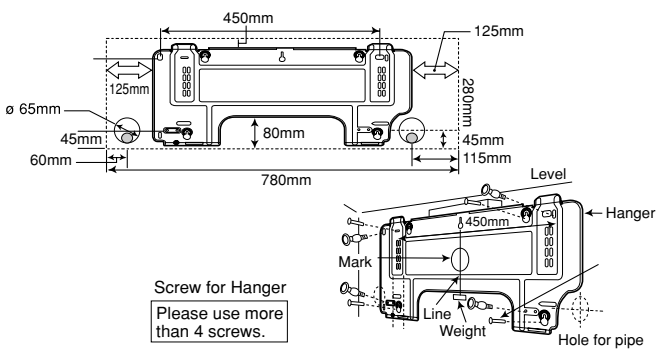

**Procedures of Installation and Precautions**

- Procedures to fix the hanger.
  1. Drill holes on wall. (As shown below)
  2. Push plug into the holes. (As shown below)
  3. Fix the hanger on wall with 4.1 x 32 screw (As shown in figure below)

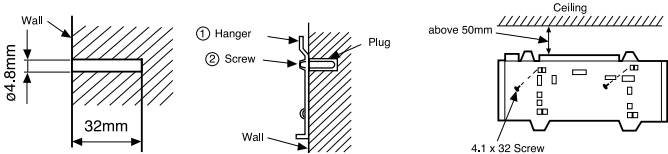

- Procedures to fix the holder of remote control.
  1. Drill holes on wall. (As shown below)
  2. Push plug into the holes. (As shown below)

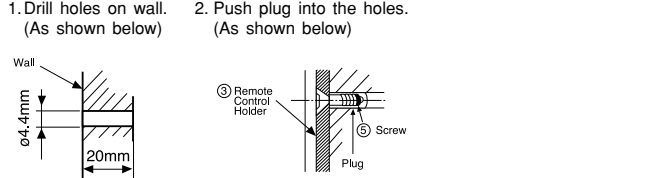

**Wall Penetration and Installation of Protection Pipe**

- Drill a  $\phi$  65mm hole on wall which is slightly tilted towards the outdoor side. Drill the wall at a small angle.
- Cut the protection pipe according to the wall thickness.
- Empty gap in the sleeve of protection pipe should be completely sealed with putty to avoid dripping of rain water into the room.

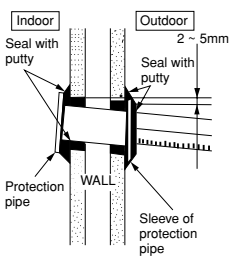

- WARNING**  
Be sure that the wire is not in contact with any metal in the wall. Please use the protection pipe as wire passing through the hollow part of the wall so as to prevent the possibility of damaged by mouse. Unless it seals completely, any air with high humidity flows from outdoor and any dew may drop.

**2 Installation of the Indoor Unit**

**VERTICALLY DOWNWARD PIPING**

**Preparation**

- Connect connecting cord.
- Pull out the pipe, connecting cord and drain hose.

**Installation**

- The upper part of the Indoor unit is hanged on the hanger.
- The projection at the lower part of the Indoor unit is hooked onto the hanger.

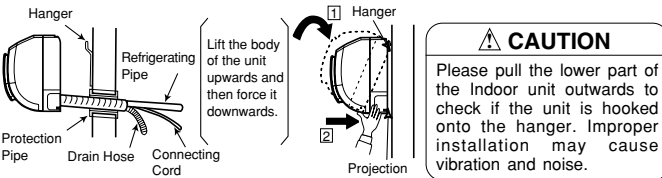

**HOW TO REMOVE INDOOR UNIT**

- Push up the (PUSH) sections at the bottom of the indoor unit and pull the bottom plate towards you. Then the claws are released from the stationary plate. (The (PUSH) sections are indicated by 2 arrows in the right figure)

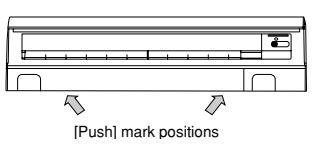

**HORIZONTAL PIPING**

**Preparation**

- Change of Drain Hose and Installation Procedures.
  - Exchange the location of drain hose and drain cap during horizontal piping as shown in figure below. Be sure to plug in the drain hose until the insulating material folds upon itself.

- Please use pliers to pull out the drain cap. (This is an easier way to remove the drain cap).

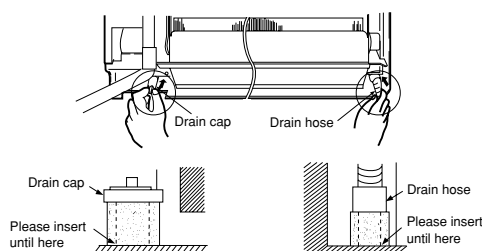

**HORIZONTAL & DOWNWARD PIPING - MAKING OPENINGS**

- During horizontal or downward piping, use a knife to cut openings as shown in figure. Then smoothen the edges of openings with a file.
- Turn the piping while holding down the lower portion of pipe-support by hand.

**INSTALLATION OF REFRIGERATING PIPES AFTER CONNECTION**

- The refrigerating pipes should be adjusted to fit into the hole on the wall and then ready for further connection.
- The terminals of 2 connected pipes must be covered with insulator used for terminal connection. Then the pipes are wrapped with insulation pipe.
- Connect the connecting cord after removing electrical cover. (Refer to "CONNECTION OF POWER CORD")
- After adjustment, fit the connecting cord and pipes into the space available under the indoor unit. Use holder to hold them tight.

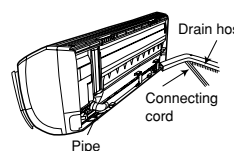

**CAUTION**

- The rubber strap used for fixing the insulator should not be tied with great force. Otherwise, this will damage heat insulation and causes water condensation.

**THE CONNECTION OF REFRIGERATING PIPE DURING THE INSTALLATION OF INDOOR UNIT**

**Preparation To Install Refrigerating Pipes**

- The refrigerating pipes and connecting cord transform and are attached.
- The end of the refrigerating pipes are at locations marked with "▽" symbol.

**CAUTION**

- Please fix in the plastic core after flaring to avoid plastic chips entering the pipes.

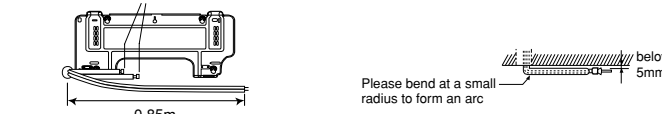

**Installation**

- Hang the Indoor unit onto the hanger. Use the temporary stand at the back of the Indoor unit to push its lower part 15cm forwards.
- Place the drain hose through the hole on the wall.
- Wrap the refrigerating pipes with insulation pipe after connecting refrigerating pipe.
- Connect the connecting cord after removing electrical cover. (Refer to "Connection of Power Cord")
- After adjustment, the connecting cord and refrigerating pipes are placed into the space available under the Indoor unit.
- The projection of Indoor unit must hook to the hanger.

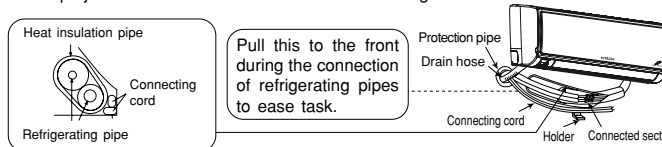

**3 Installation of Drain Hose**

- Turn the piping while holding down the lower portion of pipe-support by hand.
- You are free to choose the side (left or right) for the installation of drain hose. Please ensure the smooth flow of condensed water of the Indoor unit during installation. (Carelessness may result in water leakage.)

**CAUTION**

Be sure that the drain hose is not loosely connected or bend.

- Please mount the outdoor unit on stable ground to prevent vibration and increase of noise level.
- Decide the location for piping after sorting out the different types of pipe available.

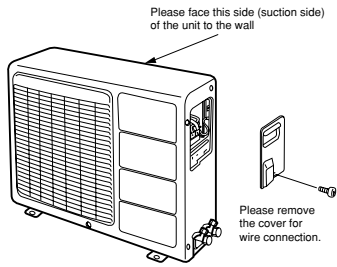

**Procedure to remove the cover of wiring terminals**

- Remove the screw (1 piece).
- Hold the projected part at the lower left of the cover and push the cover upwards to remove it.
- To close the cover, insert the upper part of the cover into the body of outdoor unit, then be sure that the hook below the cover is plugged in before screwing.

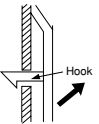

**1 Preparation of Pipe**

- Use a pipe cutter to cut the copper pipe.

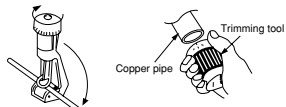

**CAUTION**

- Jagged edge will cause leakage.
- Point the side to be trimmed downwards during trimming to prevent copper chips from entering the pipe.

- Before flaring, please put on the hexagon screw cap.

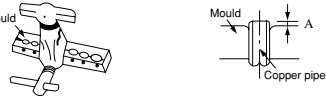

RAS-S10CY, RAS-S115CY

Outer Diameter (ø)	A (mm)	
	Imperial flaring tool	Rigid flaring tool
6.35 (1/4")	0.8 - 1.5	0 - 0.5
9.52 (3/8")	1.0 - 2.0	0 - 1.0

RAS-S13CY

Outer Diameter (ø)	A (mm)	
	Imperial flaring tool	Rigid flaring tool
6.35 (1/4")	0.8 - 1.5	0 - 0.5
12.7 (1/2")	1.0 - 2.0	0 - 1.0

**2 Pipe Connection**

- Please be careful when bending the copper pipe.
- Applied frozen grease to the connection points and then screw in manually. After that, use a torque wrench to tighten the connection.

RAS-S10CY, RAS-S115CY

	Outer dia. of pipe	Torque N.m (kgf · cm)
Small dia. side	6.35 (1/4")	13.7 - 18.6 (140 - 190)
Big dia. side	9.52 (3/8")	34.3 - 44.1 (350 - 450)
Valve head cap	19.6 - 24.5 (200 - 250)	
Valve core cap	12.3 - 15.7 (125 - 160)	

RAS-S13CY

	Outer dia. of pipe	Torque N.m (kgf · cm)
Small dia. side	6.35 (1/4")	13.7 - 18.6 (140 - 190)
Big dia. side	12.7 (1/2")	44.1 - 53.9 (450 - 550)
Valve head cap	19.6 - 24.5 (200 - 250)	
Valve core cap	12.3 - 15.7 (125 - 160)	

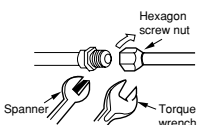

**3 Removal Of Air From The Pipe And Gas Leakage Inspection**

**Procedures of using Vacuum Pump for Air Removal**

- As shown in figure on the right, remove the cap of valve head and valve core and then connect them to the vacuum pump and sub-division valve.

- Fully tighten the "Hi" shuttle of the sub-division valve and completely unscrew the "Lo" shuttle. Run the vacuum pump for about 10-15 minutes, then completely tighten the "Lo" shuttle and switch off the vacuum pump.

- Completely unscrew the spindle of the service valve (at 2 places) in anti-clockwise direction to allow the flow of coolant (using Allen key).

- Remove the connection pipe and tighten the cap of valve head. The task is then completed.

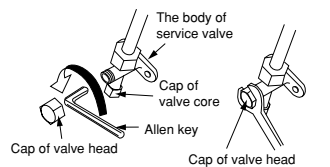
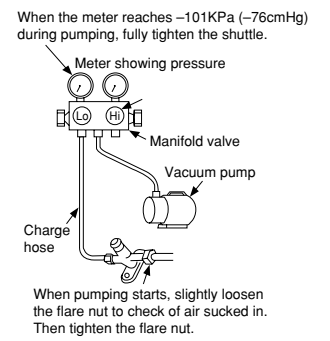

**Gas Leakage Inspection**

Please use gas leakage detector to check if leakage occurs at the connection of hexagon screw nut as shown on the right.

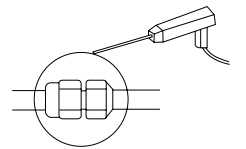

If gas leakage occurs, further tighten the connection to stop leakage.

**WARNING** • THIS APPLIANCE MUST BE EARTHED.

**Procedures of Wiring**

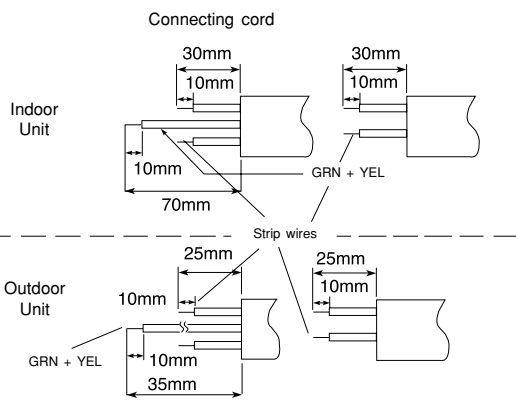
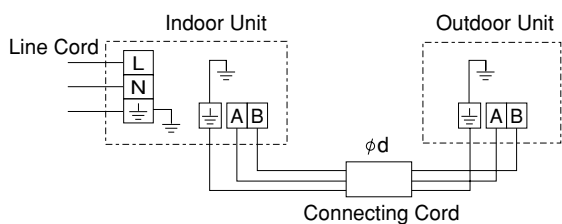

**WARNING**

- The naked part of the wire core should be 10 mm and fix it to the terminal tightly. Then try to pull the individual wire to check if the contact is tight. Improper insertion may burn the terminal.
- Be sure to use only power cables approved from the authorities in your country. For example in Germany: Cable type: NYM 3x2.0mm<sup>2</sup>.
- Please refer to the installation manual for wire connection to the terminals of the units. The cabling must meet the standards of electrical installation.
- There is an AC voltage drop between the L and N terminals if power is on. Therefore, before servicing, be sure to remove the plug from the AC outlet or switch off the main switch.

**Wiring Of The Indoor Unit**

- For wire connection of the Indoor unit, you need to remove Low Cover and Indicator Cover.

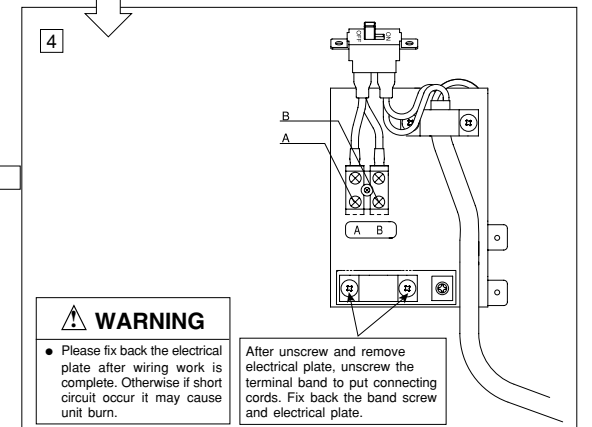
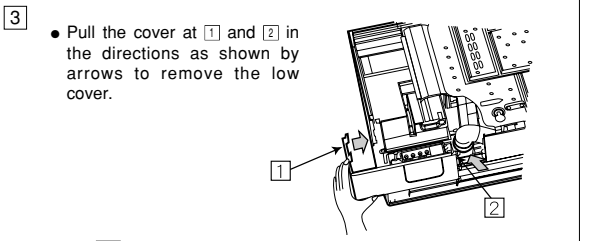
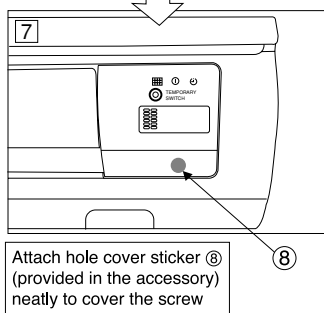
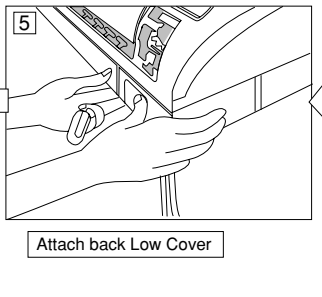
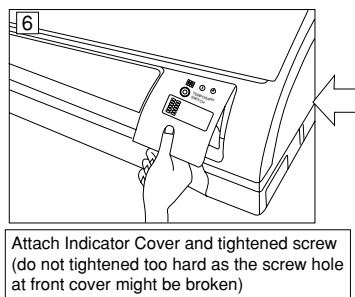
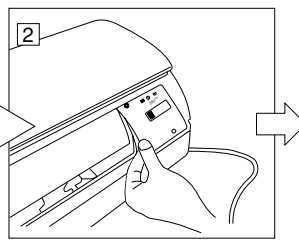
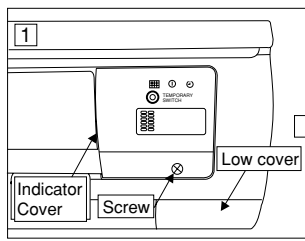

**Wiring of The Outdoor Unit**

- Please remove the side cover for wire connection.

**WARNING**

- If you cannot attach the side cover due to the connecting cord, press the connecting cord in direction to the front panel to fix it.
- Be sure that the hooks of the side cover is fixed in certainly. Otherwise water leakage may occur and this causes short circuit or faults.

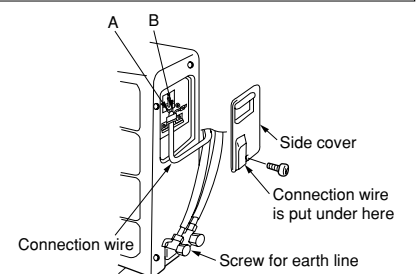

**CABLE SIZE ød**

1-25mm	RAS-S10CY, RAS-S115CY
1-50mm	RAS-S13CY

**TIME DELAY FUSE USAGE**

10A	RAC-S10CY, RAC-S115CY
15A	RAC-S13CY

**1 Insulation And Maintenance Of Pipe Connection**

- The connected terminals should be completely sealed with heat insulator and then tied up with rubber strap.
- Please tie the pipe and power line together with vinyl tape as shown in the figure showing the installation of Indoor and Outdoor units. Then fix their position with holders.
- To enhance the heat insulation and to prevent water condensation, please cover the outdoor part of the drain hose and pipe with insulation pipe.
- Completely seal any gap with putty.

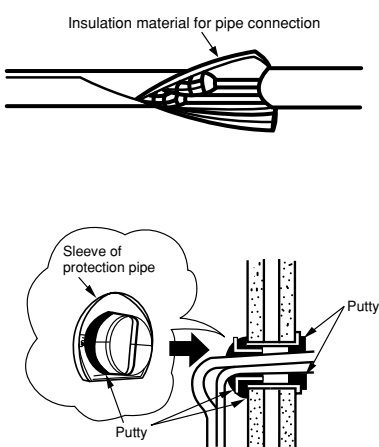

**2 Installation Of Remote Controller**

- The remote controller can be placed in its holder which is fixed on wall or beam.
- To operate the remote controller at its holder, please ensure that the unit can receive signal transmitted from the controller at the place where the holder is to be fixed. The unit will beep when signal is received from the remote controller. The signal transmission is weakened by the fluorescent light. Therefore, during the installation of the remote control holder, please switch on the light, even during day time, to determine the mounting location of the holder.

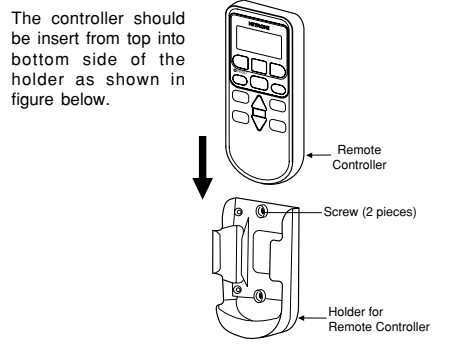

**Operation Test**

- Please ensure that the air conditioner is in normal operating condition during the operation test.
- Explain to your customer the proper operation procedures as described in the user's manual.

**3 Power Source And Operation Test**

**Power Source**

**CAUTION**

- Please use a new socket. Accident may occur due to the use of old socket because of poor contact.
- Please plug in and then remove the plug for 2 - 3 times. This is to ensure that the plug is completely plugged into the socket.
- Keep additional length for the power cord and do not render the plug under external force as this may cause poor contact.
- Do not fix the power cord with U-shape nail.