

FOR SERVICE PERSONNEL ONLY









HITACHI
Inspire the Next

SPLIT UNIT AIR CONDITIONER INSTALLATION MANUAL

Outdoor Unit  **RAM-72Q5**





- Carefully read through the procedures of proper installation before starting installation work.
- The sales agent should inform customers regarding the correct operation of installation.

Tools Needed For Installation Work

- (Mark  is exclusive use tool for R410A)
-   Screwdriver
 - Measuring Tape
 - Knife
 - Saw
 - \varnothing 65mm Power Drill
 - Hexagonal Wrench Key (\square 4mm)
 - Wrench (14, 17, 22, 26mm)
 -  Gas Leakage Detector
 - Pipe Cutter
 - Putty
 - Vinyl Tape
 - Pliers
 - Flare Tool
 -  Vacuum Pump Adapter
 -  Manifold Valve
 -  Charge Hose
 -  Vacuum Pump

SAFETY PRECAUTION

- Read the safety precautions carefully before operating the unit.
- The contents of this section are vital to ensure safety. Please pay special attention to the following sign.

-  **WARNING** Incorrect methods of installation may cause death or serious injury.
-  **CAUTION** Improper installation may result in serious consequence.
-  **Make sure to connect earth wire.**
-  **This sign in the figures indicates prohibition.**

Be sure that the unit operates in proper condition after installation. Explain to customer the proper way of operating the unit as described in the user's guide.

WARNING

- Please request your sales agent or qualified technician to install your unit. Water leakage, short circuit or fire may occur if you do the installation work yourself.
- Please observe the instructions stated in the installation manual during the process of installation. Improper installation may cause water leakage, electric shock and fire.
- Make sure that the units are mounted at locations which are able to provide full support to the weight of the units. If not, the units may collapse and impose danger.
- Observe the rules and regulations of the electrical installation and the methods described in the installation manual when dealing with the electrical work. Use power cables approved by the authorities of your country.
- Be sure to use the specified wire for connecting the indoor and outdoor units. Please ensure that the connections are tight after the conductors of the wire are inserted into the terminals. Improper insertion and loose contact may cause over-heating and fire.
- Please use the specified components for installation work. Otherwise, the units may collapse or water leakage, electric shock and fire may occur.
- Be sure to use the specified piping set for R-410A. Otherwise, this may result in broken copper pipes or faults.
- When installing or removing an air conditioner, only specified refrigerant (R410A) shall be allowed, do not allow air or moisture to remain in the refrigeration cycle. Otherwise, pressure in the refrigeration cycle may become abnormally high so that a rupture may be caused.
- Be sure to ventilate fully if a refrigerant gas leak while at work. If the refrigerant gas comes into contact with fire, a poisonous gas may occur.
- After completion of installation work, check to make sure that there is no refrigeration gas leakage. If the refrigerant gas leaks into the room, coming into contact with fire in the fan-driven heater, space heater, etc., a poisonous gas may occur.
- Unauthorized modifications to the air conditioner may be dangerous. If a breakdown occurs please call a qualified air conditioner technician or electrician. Improper repairs may result in water leakage, electric shock and fire, etc.
- Be sure to connect the earth wire from the power supply wire to the outdoor unit and between the outdoor and indoor unit. Improper earthing may cause electric shock.

CAUTION

- A circuit breaker must be installed in the house distribution box for the direct connected power supply wire to the outdoor unit. In case of other installations a main switch with a contact gap of more than 3.5mm has to be installed. Without a circuit breaker, the danger of electric shock exists.
- Do not install the unit near a location where there is flammable gas. The outdoor unit may catch fire if flammable gas leaks around it.
- Be sure to tighten the flare nut to the specified torque using a torque wrench. If the flare nut is tightened excessively, it may crack as time elapses, cause refrigerant leakage.
- Please ensure smooth flow of water when installing the drain hose.
- An IEC approved power cord should be used. Power cord type: NYM.

THE CHOICE OF MOUNTING SITE (Please note the following matters and obtain permission from customer before installation).

WARNING

- The Outdoor unit must be mounted at a location which can support heavy weight. Otherwise, noise and vibration will increase.

CAUTION

- Do not expose the unit under direct sunshine or rain. Besides, ventilation must be good and clear of obstruction.
- The air blown out of the unit should not point directly to animals or plants.
- The clearances of the unit from top, left, right and front are specified in figure below. At least 3 of the above sides must be open air.
- Be sure that the hot air blown out of the unit and noise do not disturb the neighbourhood.
- Do not install at a location where there is flammable gas, steam, oil and smoke.
- The location must be convenient for water drainage.
- Place the Outdoor unit and its connecting cord at least 1m away from the antenna or signal line of television, radio or telephone. This is to avoid noise interference.

Figure showing the Installation of Outdoor Unit.

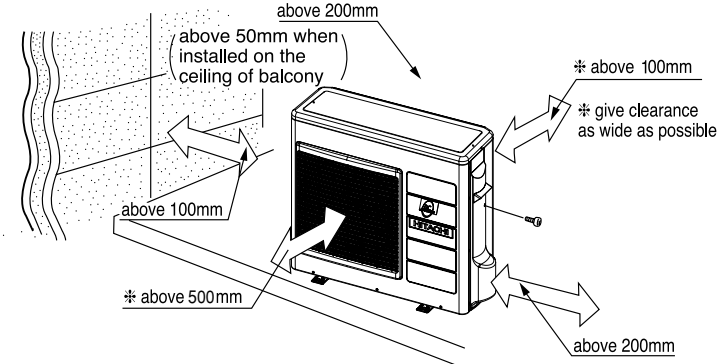
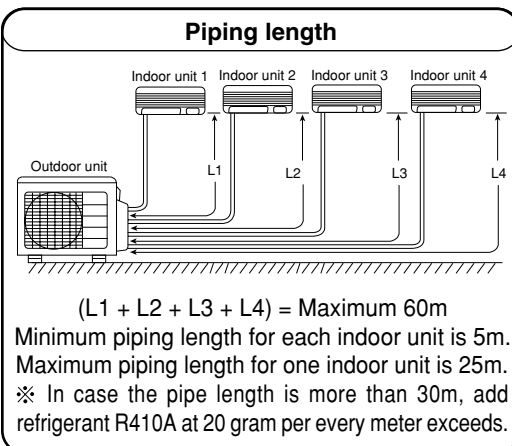
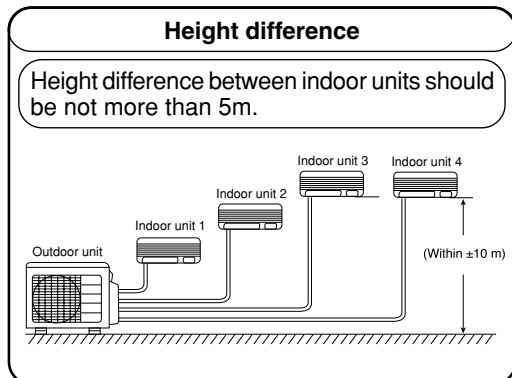
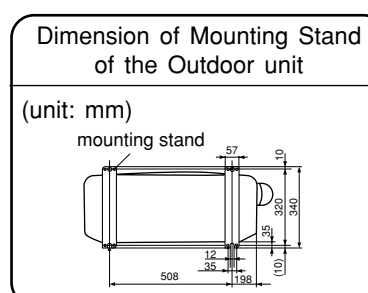

- When removing side cover, pull the handle after releasing the hook by pulling it downward.

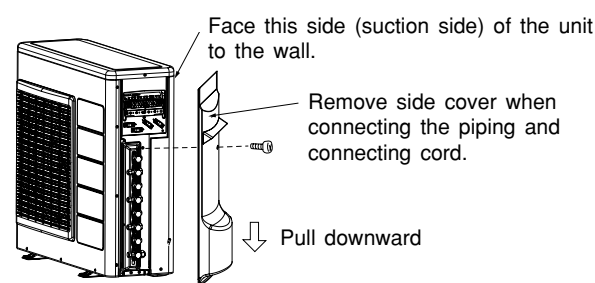

CAUTION

- Make sure to connect to two or more indoor units.

Flare adaptor for piping

The flare adaptor for piping is required depending on combination of indoor units.

- \varnothing 9.52 (3/8") \rightarrow \varnothing 12.7 (1/2")
Parts number TA261D-4 001
- \varnothing 12.7 (1/2") \rightarrow \varnothing 9.52 (3/8")
Parts number TA261D-6 002

[Outdoor unit installation]

- Mount the Outdoor unit on stable ground to prevent vibration and increase of noise level.
- Decide the location for piping after sorting out the different types of pipe available.

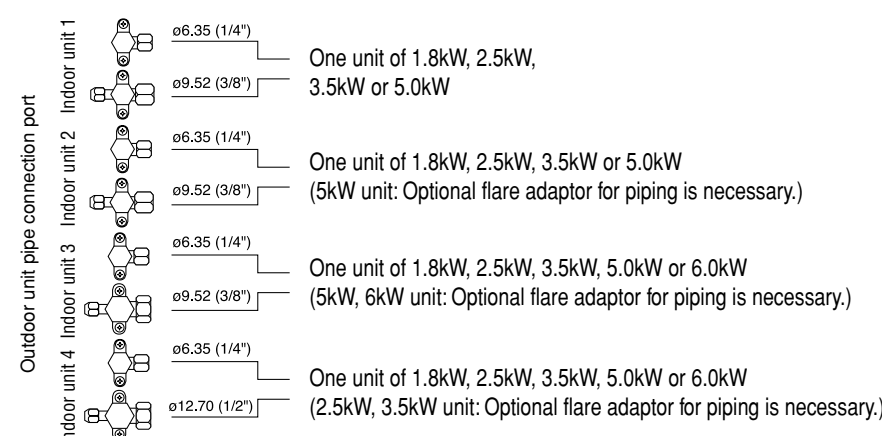

- To the outdoor unit, up to four indoor units can be connected until the total value of each units' capacity reaches 11 kW.
- The pipe connection ports of the outdoor unit and connectable indoor units are shown above.

If you wish to prepare the copper tubes and insulation material in the field, we recommend the following.

| No. | Material | Specification | |
|-----|-----------------------------------|--------------------------------------------------------------------------------------------------------------------------------------------------------------------------------------|------------------------------------------------------------------------------------|
| 1 | Cooper tube | 4.0kW or less | Small dia. Deoxidized annealed copper pipe with 6.35mm O.D., 0.8mm wall thickness. |
| | | Large dia. Deoxidized annealed copper pipe with 9.52mm O.D., 1.0mm wall thickness. | |
| | 5.0kW or more | Small dia. Deoxidized annealed copper pipe with 6.35mm O.D., 0.8mm wall thickness. | |
| | | Large dia. Deoxidized annealed copper pipe with 12.7mm O.D., 1.0mm wall thickness. | |
| 2 | Flare nut | 4.0kW or less | Small dia. Flare nuts with 6.35mm O.D.. |
| | | Large dia. Flare nuts with 9.52mm O.D.. | |
| | 5.0kW or more | Small dia. Flare nuts with 6.35mm O.D.. | |
| | | Large dia. Flare nuts with 12.7mm O.D.. | |
| 3 | Insulation for refrigerating pipe | Foamed polyethylene insulation pipe which does not corrode the copper tube. Large dia. pipe side: 15mm I.D., 8mm wall thickness. Small dia. pipe side: 8mm I.D., 7mm wall thickness. | |
| 4 | Connecting cord | Refer to item 3.3. | |
| 5 | Vinyl tape | | |
| 6 | Sealer (Putty) | | |
| 7 | Refrigerator oil | | |
| 8 | Bushing for refrigerating pipes | | |

1. Proper place for installation

1.1 Outdoor unit

- (1) Keep the space around the unit for maintenance and avoiding the effects of hindrance for normal ventilation of the unit.
- (2) The northern or eastern side of the building is better to install. At the installation on the southern or western side unavoidably, some blind should be set up for the unit. (In this case, the blind must not obstruct the ventilation of the unit.)
- (3) You'd better not put the unit at a place where is full of dirt and at a place where is wet in the rain.
- (4) Place as near as possible to the indoor unit.
- (5) Install the unit in a stable place to minimize vibration or noise.
- (6) After arranging the cords and pipes, secure them in place.

WARNING

- This appliance must be earthed.
- Power is supplied through outdoor unit, do not connect power source to indoor unit.

2. In the electrical installation a separator with a contact gap of more than 3mm has to be installed. During cleaning or service the set has to be switched off with this separator.

3. Installation procedure and notice

Especially, the selection of installation place need great care for the split type air conditioner, because it is very difficult to move from place to place after the first installation.

3.1 Wiring

- (1) Connect the electrical wiring between the Indoor and Outdoor unit, as shown in Fig. 3-1. Never connect the wiring by mistake. In case of wrong connection, the unit does not operate properly and it may cause malfunction.
- (2) The connecting cord must be fixed by the band which is located near the terminal board.

Procedures of Wiring

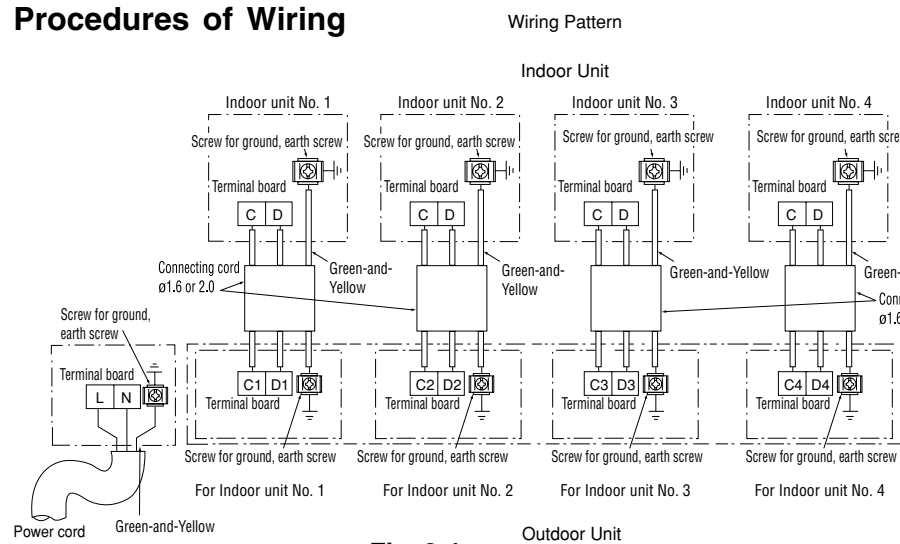

Fig. 3-1

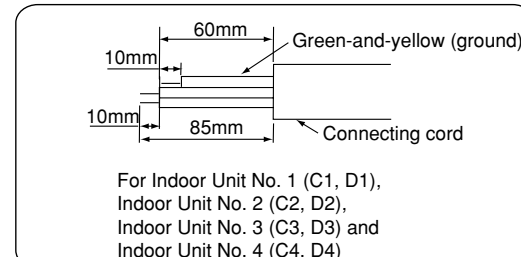
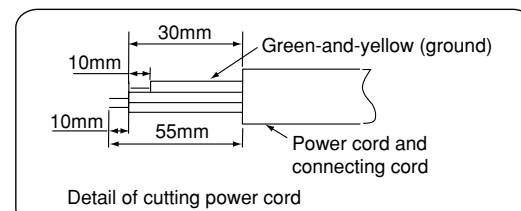

Fig. 3-2

WARNING

- The naked part of the wire core should be 10 mm and fix it to the terminal tightly. Then try to pull the individual wire to check if the contact is tight. Improper insertion may burn the terminal.
- Be sure to use only power cables approved from the authorities in your country. For example in Germany: Cable type: NYM 3x1.5mm². (fuse = 16A time delay)
- Please refer to the installation manual for wire connection to the terminals of the units. The cabling must meet the standards of electrical installation.
- There is a AC voltage of 220-240V between the L and N terminals. Therefore, before servicing, be sure to remove the plug from the AC outlet or switch off the main switch.

Wiring of The Outdoor Unit

- Please remove the side cover for wire connection.

WARNING

- If you cannot attach the side cover due to the connecting cord, press the connecting cord in direction to the front panel to fix it.
- Be sure that the hooks of the side cover is fixed in certainly. Otherwise water leakage may occur and this causes short circuit or faults.
- The connecting cord should not touch to service valve and pipes. (It becomes high temperature in heating operation.)

3.3 Checking for the electric source and the voltage range

- Before installation, the power source must be checked and necessary wiring work must be completed. To make the wiring capacity proper, use the wire gauges list below for the lead-in from a pole transformer and for the wiring from a switch board of fuse box to the main switch and outdoor unit in consideration of the locked rotor current.

IMPORTANT

| Cable length | Wire cross-section |
|--------------|--------------------|
| up to 6m | 1.5mm ² |
| up to 15m | 2.5mm ² |
| up to 25m | 4.0mm ² |

WARNING

- Connect the Connecting Cord to C1 and D1 "Indoor 1" for indoor unit 1, C2 and D2 "Indoor 2" for indoor unit 2, C3 and D3 "Indoor 3" for indoor unit 3, C4 and D4 "Indoor 4" for indoor unit 4.

Bind connecting cords to make them fit between the convex sections.

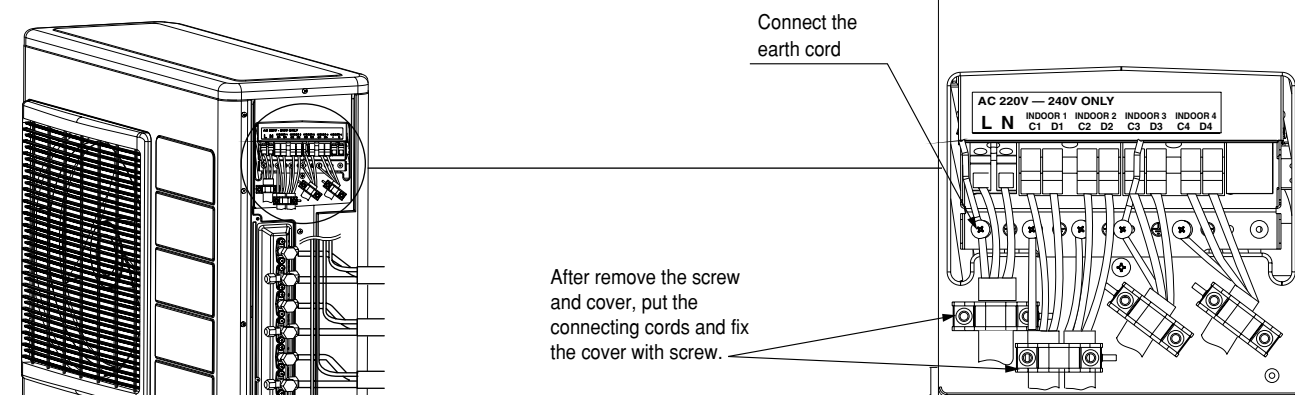

CAUTION

Arrange power cord so they do not touch service valve.

Fig. 3-3

| Type of grounding rod | Length |
|-----------------------|--------|
| SP-EB-2 | 900mm |

Grounding rod (optional)

(Earth wire and grounding rod are not supplied. Please use optional items below.)

- Investigate the power supply capacity and other electrical conditions at the installation location. Depending on the model of room air conditioner to be installed, request the customer to make arrangements for the necessary electrical work etc. The electrical work includes the wiring work up the outlet. In localities where electrical conditions are poor, use of a voltage regulation is recommended.

IMPORTANT

| |
|---------------------|
| Fuse Capacity |
| 30A time delay fuse |

4. Preparation of Pipe

- Use a pipe cutter to cut the copper pipe.

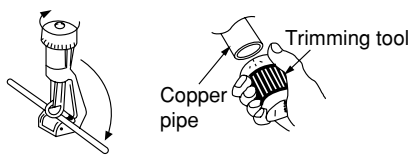

- Before flaring, please put on the flare nut.

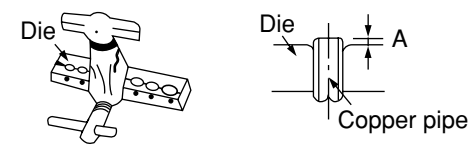

- Please use exclusive tool

5. Pipe Connection

5.1 Pipe connection Connecting the pipe to outdoor unit

- Remove the flare nut and seal cap from the service valve.
- Apply refrigerator oil to the service valve and the flared portion of the pipe.
- Using a wrench, security tighten.

Tighten all the way by hand.

Do not tighten all at once, but tighten it while fitting the flared surface to the pipe.

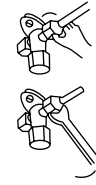

CAUTION

- In case of removing flare nut of a indoor unit, first remove a nut of small diameter side, or seal cap of large diameter side will fly out. Free from water into the piping when working.
- During connection, keep away from water.
- Be sure to tighten the flare nut to the specified torque using a torque wrench. If the flare nut is tightened excessively, it may crack as time elapses, causing refrigerant leakage.

- Please be careful when bending the copper pipe.
- Screw in manually while adjusting the center. After that, use of torque wrench to tighten the connection.

| | Outer diameter of pipe (Ø) | Torque N·m (kgf · cm) | |
|----------------|----------------------------|-----------------------|---------------------|
| | | Small diameter side | Large diameter side |
| Flare nut | 6.35 (1/4") | 13.7-18.6 (140-190) | 34.3-44.1 (350-450) |
| | 9.52 (3/8") | 19.6-24.5 (200-250) | 44.1-53.9 (450-550) |
| | 12.7 (1/2") | 19.6-24.5 (200-250) | 29.4-34.3 (300-350) |
| Valve head cap | Small diameter side | 12.3-15.7 (125-160) | |
| | Large diameter side | | |
| Valve core cap | | 12.3-15.7 (125-160) | |

- Install the unit in a stable place to minimize vibration or noise.
- After arranging the cords and pipes, secure them in place.

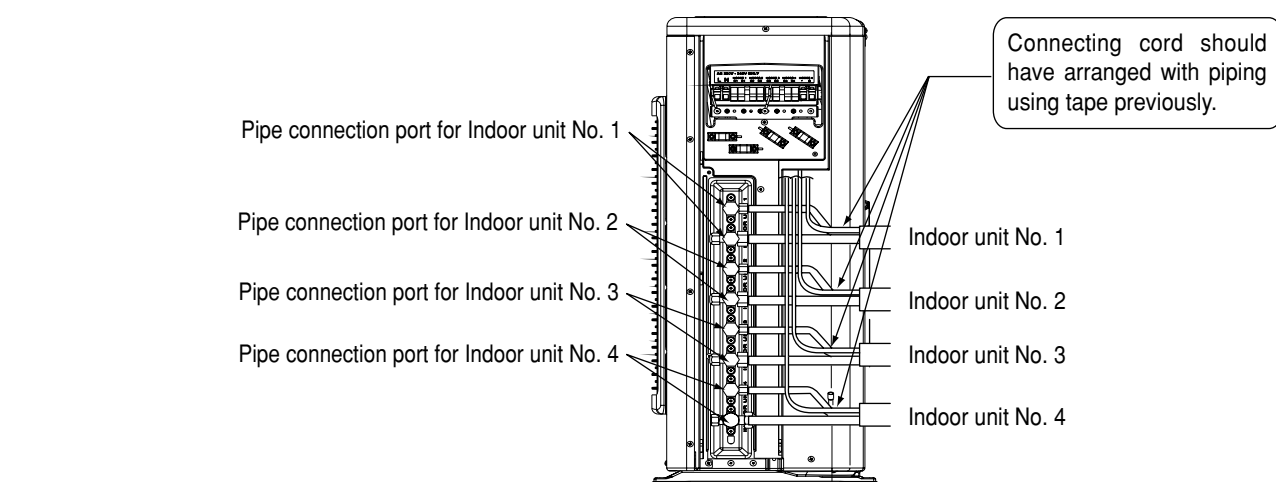

Gas leakage inspection

Please use gas leakage detector to check if leakage occurs at connection of flare nut as shown on the right. If gas leakage occurs, further tighten the connection to stop leakage. (Use the detector provided for R410A)

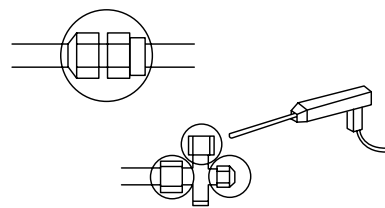

6. Removal Of Air From The Pipe And Gas Leakage Inspection

6.1 Air purging by using vacuum pump

- Remove the valve cap of valve core.
- Connect the charge hoses to the vacuum pump and the charge port of the valve core large dia. pipe side service valve, respectively.
- Fully open the LO knob of the manifold valve.
- Run the vacuum pump.
 - Vacuum for more than 10 min.
- Close the LO knob of the manifold valve.
- Stop the vacuum pump.
- Remove the valve cap from the spindle of the service valve.
- Turn the spindles of each large and small dia. pipe side service valves full counterclockwise until they are securely tightened. Then retighten them more than 10 degrees [using a hexagon wrench key (4mm) without fail].
- Disconnect the charge hose from the service valve.
- Tighten the valve cap of valve core. [Torque 12.3 - 15.7 N·m (125 - 160 kgf·cm)]
- Attach the valve cap to the spindles of each large and small dia. pipe side service valves.
- Tighten the valve cap of the spindle. [Torque 19.6 - 24.5 N·m (200 - 250 kgf·cm)]

Air purging by vacuum pump

When the meter reaches -101KPa (-76cmHg) during pumping, fully tighten the shuttle.

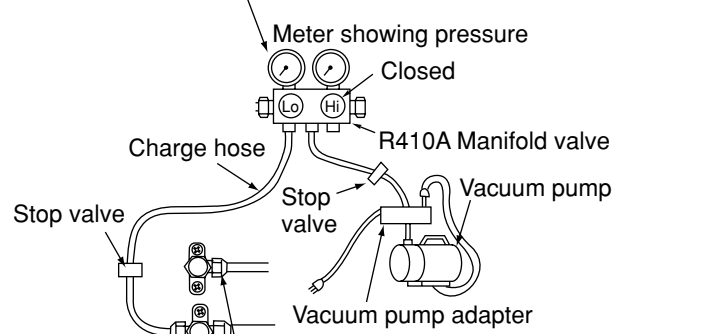

When pumping starts, slightly loosen the flare nut to check of air sucked in. Then tighten the flare nut. Be sure the stop valve is always fully opened.

Fig. 6-1

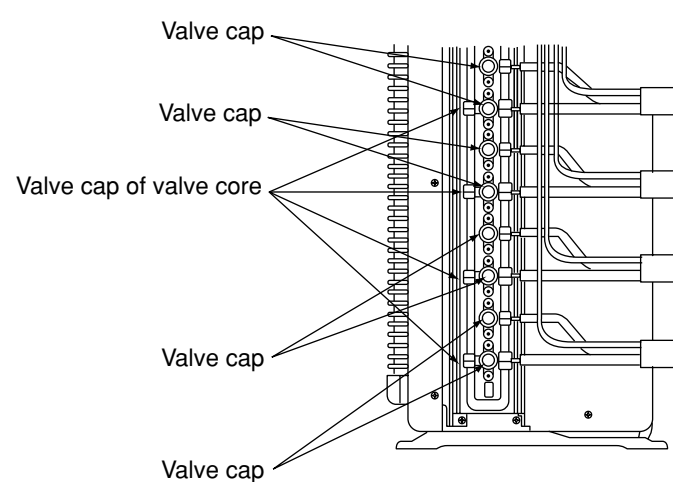

Fig. 6-2

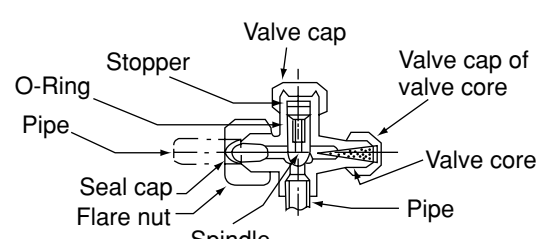

Fig. 6-3

The refrigerant channel is opened so that the refrigerant will flow from the outdoor unit into the indoor unit.

7. Operation test

- Please ensure that the air conditioner is in normal operating condition during the operation test.
- Explain to your customer the proper operation procedures as described in the user's manual.
- If the indoor unit does not operate, check to see that the connections are correct.

CAUTION

- Trial run should be conducted on one unit at a time to check for incorrect wiring of connecting cord.

4 ROOM MULTI-SPLIT INVERTER TYPE ROOM AIR CONDITIONER POSSIBLE COMBINATION TO OPERATE (SAME TIME OPERATION)

(Reference value)

| POSSIBLE COMBINATIONS TO OPERATE | COOLING | | | | | |
|----------------------------------|------------------------------|---------------------------|-----------------------|------------------------|-------------|------|
| | CAPACITY RATING (kW) (RANGE) | TOTAL | OUTDOOR UNIT | | COP | |
| | | | POWER CONSUMPTION (W) | AMPERE (A) at 220-240V | | |
| ONE UNIT | 1.8 | 1.80 | 1.80 | 450 | 2.1 - 1.9 | 4.00 |
| | 2.5 | 2.50 | 2.50 | 650 | 3.0 - 2.7 | 3.85 |
| | 3.5 | 3.50 | 3.50 | 1030 | 4.7 - 4.3 | 3.40 |
| | 5.0 | 5.00 | 5.00 | 1640 | 7.5 - 6.9 | 3.05 |
| | 6.0 | 6.00 | 6.00 | 2080 | 9.6 - 8.8 | 2.88 |
| TWO UNITS | 1.8 + 1.8 | 1.80 + 1.80 | 3.60 | 830 | 3.8 - 3.5 | 4.34 |
| | 1.8 + 2.5 | 1.80 + 2.50 | 4.30 | 1120 | 5.1 - 4.7 | 3.84 |
| | 1.8 + 3.5 | 1.80 + 3.50 | 5.30 | 1600 | 7.3 - 6.7 | 3.31 |
| | 1.8 + 5.0 | 1.80 + 5.00 | 6.80 | 2420 | 11.1 - 10.2 | 2.81 |
| | 1.8 + 6.0 | 1.70 + 5.40 | 7.10 | 2450 | 11.2 - 10.3 | 2.90 |
| | 2.5 + 2.5 | 2.50 + 2.50 | 5.00 | 1410 | 6.5 - 5.9 | 3.55 |
| | 2.5 + 3.5 | 2.50 + 3.50 | 6.00 | 1950 | 9.0 - 8.2 | 3.08 |
| | 2.5 + 5.0 | 2.40 + 4.70 | 7.10 | 2530 | 11.6 - 10.6 | 2.81 |
| | 2.5 + 6.0 | 2.10 + 5.00 | 7.10 | 2450 | 11.2 - 10.3 | 2.90 |
| | 3.5 + 3.5 | 3.50 + 3.50 | 7.00 | 2630 | 12.1 - 11.1 | 2.66 |
| | 3.5 + 5.0 | 2.90 + 4.20 | 7.10 | 2530 | 11.6 - 10.6 | 2.81 |
| | 3.5 + 6.0 | 2.60 + 4.50 | 7.10 | 2450 | 11.2 - 10.3 | 2.90 |
| | 5.0 + 5.0 | 3.55 + 3.55 | 7.10 | 2530 | 11.6 - 10.6 | 2.81 |
| 5.0 + 6.0 | 3.20 + 3.90 | 7.10 | 2360 | 10.8 - 9.9 | 3.01 | |
| THREE UNITS | 1.8 + 1.8 + 1.8 | 1.80 + 1.80 + 1.80 | 5.40 | 1250 | 5.7 - 5.3 | 4.32 |
| | 1.8 + 1.8 + 2.5 | 1.80 + 1.80 + 2.50 | 6.10 | 1590 | 7.3 - 6.7 | 3.84 |
| | 1.8 + 1.8 + 3.5 | 1.80 + 1.80 + 3.50 | 7.10 | 2210 | 10.1 - 9.3 | 3.21 |
| | 1.8 + 1.8 + 5.0 | 1.50 + 1.50 + 4.10 | 7.10 | 2180 | 10.0 - 9.2 | 3.26 |
| | 1.8 + 1.8 + 6.0 | 1.35 + 1.35 + 4.40 | 7.10 | 2160 | 9.9 - 9.1 | 3.29 |
| | 1.8 + 2.5 + 2.5 | 1.80 + 2.50 + 2.50 | 6.80 | 2040 | 9.4 - 8.6 | 3.33 |
| | 1.8 + 2.5 + 3.5 | 1.65 + 2.25 + 3.20 | 7.10 | 2210 | 10.1 - 9.3 | 3.21 |
| | 1.8 + 2.5 + 5.0 | 1.40 + 1.90 + 3.80 | 7.10 | 2180 | 10.0 - 9.2 | 3.26 |
| | 1.8 + 2.5 + 6.0 | 1.25 + 1.70 + 4.15 | 7.10 | 2160 | 9.9 - 9.1 | 3.29 |
| | 1.8 + 3.5 + 3.5 | 1.40 + 2.85 + 2.85 | 7.10 | 2210 | 10.1 - 9.3 | 3.21 |
| | 1.8 + 3.5 + 5.0 | 1.25 + 2.40 + 3.45 | 7.10 | 2180 | 10.0 - 9.2 | 3.26 |
| | 2.5 + 2.5 + 2.5 | 2.36 + 2.36 + 2.36 | 7.10 | 2210 | 10.1 - 9.3 | 3.21 |
| | 2.5 + 2.5 + 3.5 | 2.10 + 2.10 + 2.90 | 7.10 | 2210 | 10.1 - 9.3 | 3.21 |
| | 2.5 + 2.5 + 5.0 | 1.80 + 1.80 + 3.50 | 7.10 | 2180 | 10.0 - 9.2 | 3.26 |
| | 2.5 + 2.5 + 6.0 | 1.60 + 1.60 + 3.90 | 7.10 | 2160 | 9.9 - 9.1 | 3.29 |
| 2.5 + 3.5 + 3.5 | 1.90 + 2.60 + 2.60 | 7.10 | 2210 | 10.1 - 9.3 | 3.21 | |
| 2.5 + 3.5 + 5.0 | 1.60 + 2.25 + 3.25 | 7.10 | 2180 | 10.0 - 9.2 | 3.26 | |
| 3.5 + 3.5 + 3.5 | 2.36 + 2.36 + 2.36 | 7.10 | 2140 | 9.8 - 9.0 | 3.32 | |
| FOUR UNITS | 1.8 + 1.8 + 1.8 + 1.8 | 1.77 + 1.77 + 1.77 + 1.77 | 7.10 | 2140 | 9.8 - 9.0 | 3.32 |
| | 1.8 + 1.8 + 1.8 + 2.5 | 1.60 + 1.60 + 1.60 + 2.30 | 7.10 | 2140 | 9.8 - 9.0 | 3.32 |
| | 1.8 + 1.8 + 1.8 + 3.5 | 1.45 + 1.45 + 1.45 + 2.75 | 7.10 | 2140 | 9.8 - 9.0 | 3.32 |
| | 1.8 + 1.8 + 1.8 + 5.0 | 1.25 + 1.25 + 1.25 + 3.35 | 7.10 | 2140 | 9.8 - 9.0 | 3.32 |
| | 1.8 + 1.8 + 2.5 + 2.5 | 1.50 + 1.50 + 2.05 + 2.05 | 7.10 | 2140 | 9.8 - 9.0 | 3.32 |
| | 1.8 + 1.8 + 2.5 + 3.5 | 1.35 + 1.35 + 1.80 + 2.60 | 7.10 | 2140 | 9.8 - 9.0 | 3.32 |
| | 1.8 + 1.8 + 3.5 + 3.5 | 1.20 + 1.20 + 2.35 + 2.35 | 7.10 | 2140 | 9.8 - 9.0 | 3.32 |
| | 1.8 + 2.5 + 2.5 + 2.5 | 1.40 + 1.90 + 1.90 + 1.90 | 7.10 | 2140 | 9.8 - 9.0 | 3.32 |
| | 1.8 + 2.5 + 2.5 + 3.5 | 1.25 + 1.75 + 1.75 + 2.35 | 7.10 | 2140 | 9.8 - 9.0 | 3.32 |
| | 2.5 + 2.5 + 2.5 + 2.5 | 1.77 + 1.77 + 1.77 + 1.77 | 7.10 | 2140 | 9.8 - 9.0 | 3.32 |
| 2.5 + 2.5 + 2.5 + 3.5 | 1.60 + 1.60 + 1.60 + 2.30 | 7.10 | 2380 | 10.9 - 10.0 | 2.98 | |

<REMARKS>

- * ONE UNIT INDICATED ARE ONLY FOR ONE UNIT OPERATION WHEN TWO OR THREE OR FOUR INDOOR UNITS ARE CONNECTED.
- * TWO UNITS INDICATED ARE ONLY FOR TWO UNITS OPERATION WHEN TWO OR THREE OR FOUR INDOOR UNITS ARE CONNECTED.
- * THREE UNITS INDICATED ARE ONLY FOR THREE UNITS OPERATION WHEN THREE OR FOUR INDOOR UNITS ARE CONNECTED.