

Indoor Unit
RAS-13CE9G
RAS-13C9G

Outdoor Unit
RAC-13CE9G
RAC-13C9G

- Carefully read through the procedures of proper installation before starting installation work.
- The sales agent should inform customers regarding the correct operation of installation.

Tools Needed For Installation Work

- $\oplus \ominus$ Screwdriver
- Measuring Tape
- Knife
- Saw
- ϕ 65mm Power Drill
- Allen Key (\boxtimes 4mm)
- Wrench (14, 17, 19, 22mm)
- Gas Leakage Detector
- Pipe Cutter
- Plastic Tape
- Pliers
- Flare Tool

SAFETY PRECAUTION

- Read the safety precautions carefully before operating the unit.
- The contents of this section are vital to ensure safety. Please pay special attention to the following sign.

WARNING Incorrect methods of installation may cause death or serious injury.

CAUTION Improper installation may result in serious consequence.

Be sure that the unit operates in proper condition after installation. Explain to customer the proper way of operating the unit as described in the user's guide.

WARNING

- Please request your sales agent or qualified technician to install your unit. Water leakage, short circuit or fire may occur if you do the installation work yourself.
- Please observe the instructions stated in the installation manual during the process of installation. Improper installation may cause water leakage, electric shock and fire.
- Make sure that the units are mounted at locations which are able to provide full support to the weight of the units. If not, the units may collapse and impose danger.
- Observe the rules and regulations of the electrical installation and the methods described in the installation manual when dealing with the electrical work. Use wire which is specified for the air conditioner. A short circuit and fire may occur due to the use of low quality wire or improper work.
- Be sure to use the specified wire for connecting the indoor and outdoor units. Please ensure that the connections are tight after the conductors of the wire are inserted into the terminals. Improper insertion and loose contact may cause over-heating and fire.
- Please use the specified components for installation work. Otherwise, the units may collapse or water leakage, electric shock and fire may occur.
- Do not mix any coolant other than R-22 into the cooling circulation path when mounting or shifting the unit. If it is mixed with air, the high pressure in the circulation path will rise and this may result in broken copper pipes or faults.

CAUTION

- Be sure to use the earth line. Do not place earth line near gas or water pipes, lightning conductor and the earth line of telephone. Improper earthing may cause electric shocks.
- A circuit breaker should be installed depending on the mounting size of the unit. Without a circuit breaker, the danger of electric shock exists.
- Do not install the unit near a location where there is flammable gas. The outdoor unit may catch fire if flammable gas leaks around it.
- Please ensure smooth flow of water when installing the drain hose.

THE CHOICE OF MOUNTING SITE (Please note the following matters and obtain permission from customer before installation).

WARNING

- The unit should be mounted at stable, non-vibratory location which can provide full support to the unit.

CAUTION

- No nearby heat source and no obstruction near the air outlet is allowed.
- The clearance distances from top, right and left are specified in figure below.
- The location must be convenient for water drainage and pipe connection with the Outdoor unit.
- To avoid interference from noise please place the unit and its remote controller at least 1m from the radio, television and inverter type fluorescent lamp.
- To avoid any error in signal transmission from the remote controller, please put the controller far away from high-frequency machines and high-power wireless systems.
- The installation height of indoor unit must be 2.3m or more in a non public area.

WARNING

- The outdoor unit must be mounted at a location which can support heavy weight. Otherwise, noise and vibration will increase.

CAUTION

- Do not expose the unit under direct sunshine or rain. Besides, ventilation must be good and clear of obstruction.
- The air blown out of the unit should not point directly to animals or plants.
- The clearances of the unit from top, left, right and front are specified in figure below. At least three of the above sides must be open air.
- Be sure that the hot air blown out of the unit and noise do not disturb the neighbourhood.
- Do not install at a location where there is flammable gas, steam, oil and smoke.
- The location must be convenient for water drainage.
- Place the outdoor unit and its connection wire at least 1m away from the antenna or signal line of television, radio or telephone. This is to avoid noise interference.

Names of Indoor Components

No.	Component's Name	Qty
①	Mounting Plate	1
②	Screw for Mounting Plate (4.1 x 32)	6
③	Holder for Remote Controller	1
④	AAA Size Battery	2
⑤	Screw for holder of Remote Controller (3.1 x 16)	2
⑥	Remote Controller	1
⑦	* Purifying Filter	1

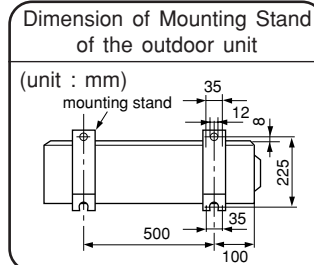
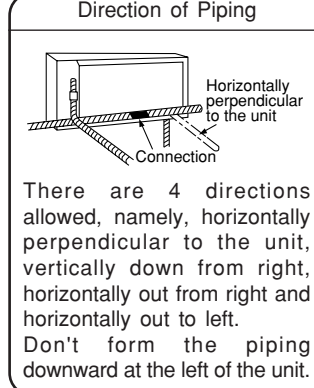
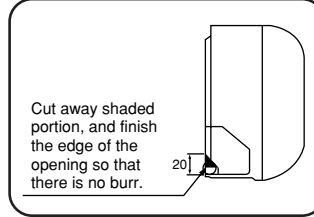
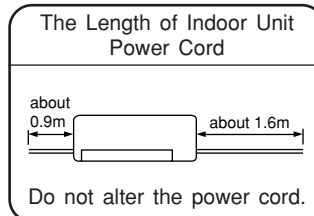

* For model RAS-13CE9G

Figure showing the Installation of Indoor and Outdoor Unit.

CAUTION

In case the pipe length is more than 8m, add refrigerant R22 at 15 gram per every meter exceeds. However, pipe length shall not exceed 15m.

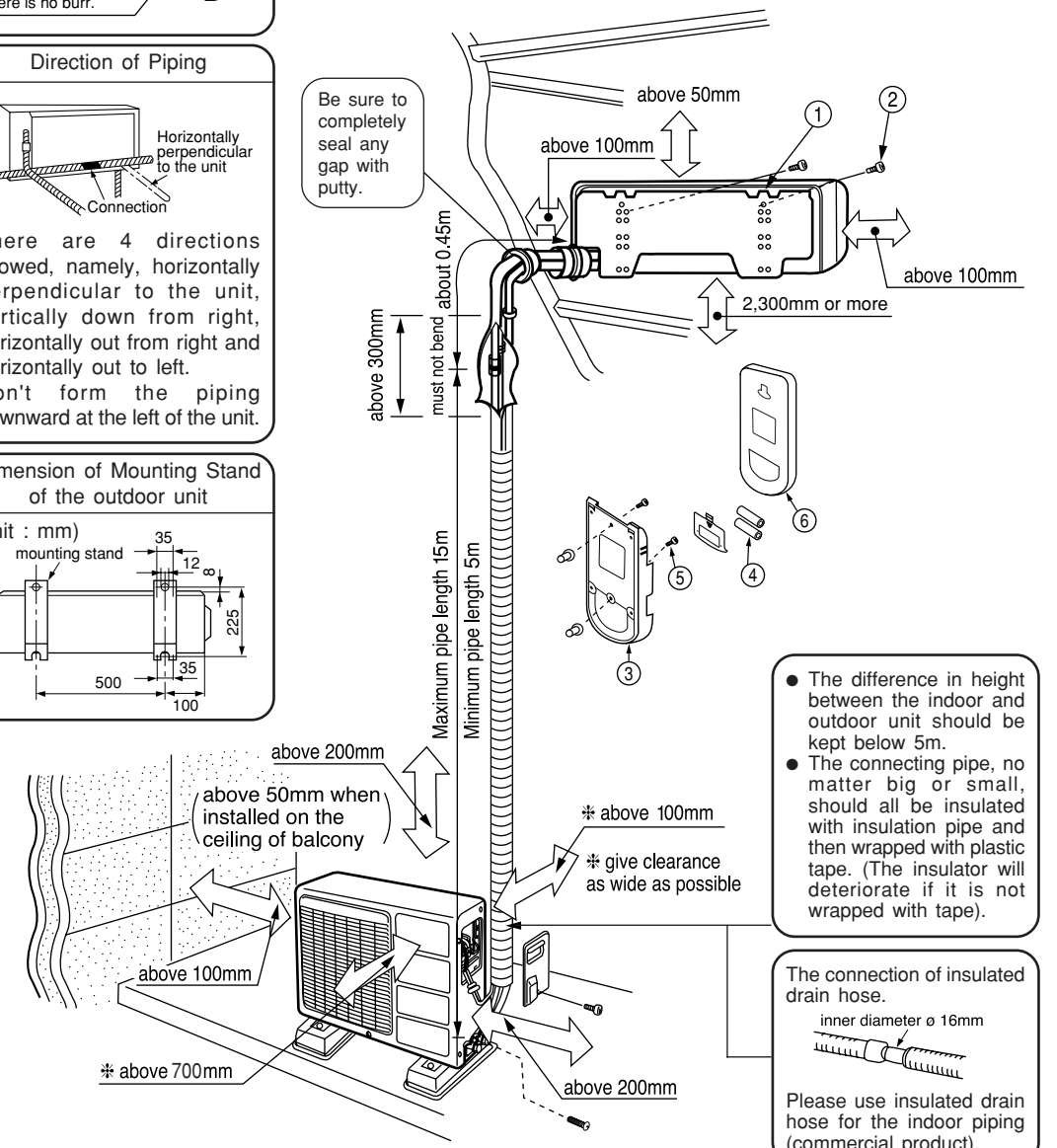

- The difference in height between the indoor and outdoor unit should be kept below 5m.
- The connecting pipe, no matter big or small, should all be insulated with insulation pipe and then wrapped with plastic tape. (The insulator will deteriorate if it is not wrapped with tape.)

The connection of insulated drain hose.
inner diameter ϕ 16mm
Please use insulated drain hose for the indoor piping (commercial product).

1 Installation of Mounting Plate, Wall Penetration and Installation of Protection Pipe

CAUTION

- The draining of the water container inside the indoor unit can be done from the left. Therefore the mounting plate must be fixed horizontally or slightly tilted towards the side of drain hose. Otherwise, condensed water may overflow the water container.

Direct Mounting On The Wall

- Please use hidden beams in the wall to hold the mounting plate.

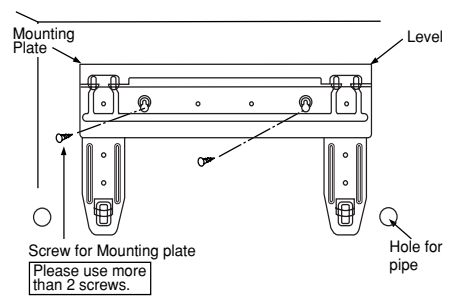
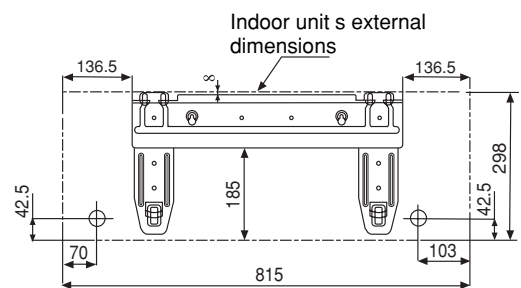

Procedures of Installation and Precautions

- Procedures to fix the mounting plate.
 1. Drill holes on wall. (As shown below)
 2. Fix the mounting plate on wall with 4.1 x 32 screw (As shown in figure below)

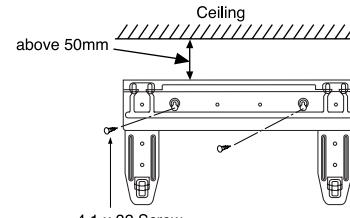
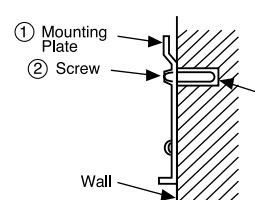
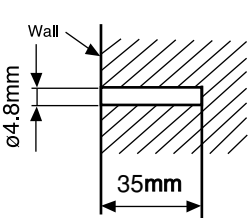

- Procedures to fix the holder of remote control.

- 1. Drill holes on wall. (As shown below)

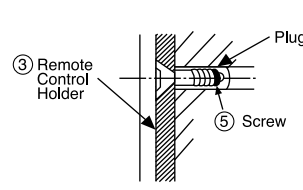
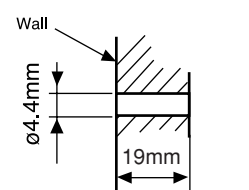

Wall Penetration and Installation of Protection Pipe

- Drill a ϕ 65mm hole on wall which is slightly tilted towards the outdoor side. Drill the wall at a small angle.
- Cut the protection pipe according to the wall thickness.
- Empty gap in the sleeve of protection pipe should be completely sealed with putty to avoid dripping of rain water into the room.

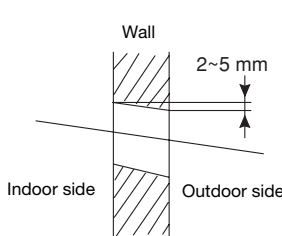

CAUTION

Be sure that the wire is not in contact with any metal in the wall. Please use the protection pipe as wire passing through the hollow part of the wall so as to prevent the possibility of damaged by mouse.

2 Installation of the Indoor Unit

VERTICALLY DOWNWARD PIPING

Preparation

- Connect power cord.
- Pull out the pipe, power cord and drain hose.



Installation

- The upper part of the indoor unit is hanged on the mounting plate.
- The projection at the lower part of the indoor unit is hooked onto the mounting plate.

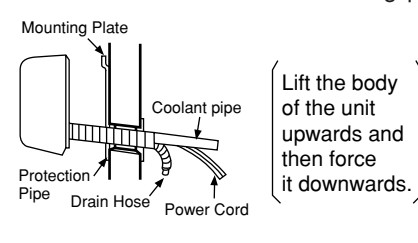

CAUTION

Please pull the lower part of the indoor unit outwards to check if the unit is hooked onto the mounting plate. Improper installation may cause vibration and noise.

HORIZONTAL PIPING

Preparation

Change of Drain Hose and Installation Procedures.

- Exchange the location of drain hose and drain cap during horizontal piping as shown in figure below. Be sure to plug in the drain hose until the insulating material folds upon itself.

- Please use pliers to pull out the drain cap. (This is an easier way to remove the drain cap).

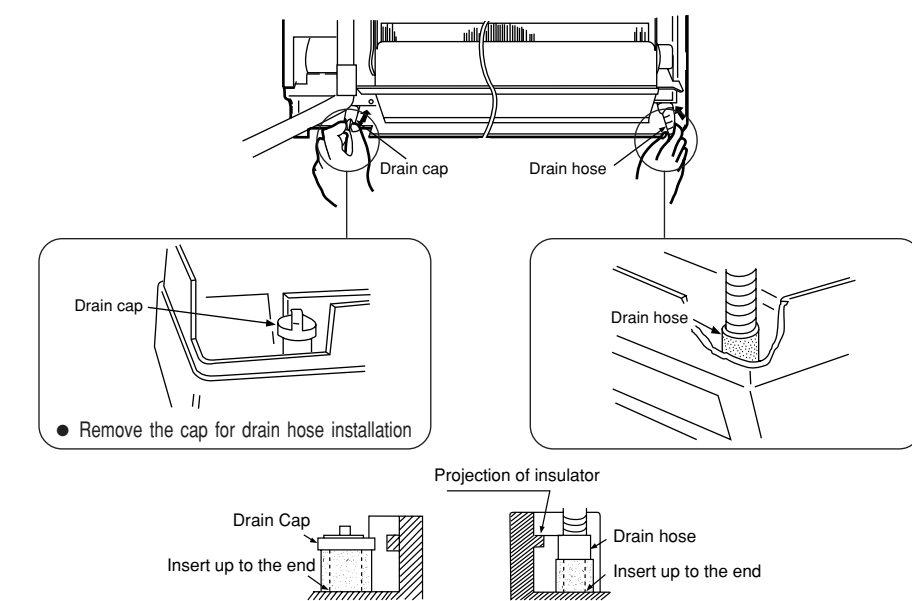

CAUTION Condensed water may leak out if not inserted properly.

HORIZONTAL & DOWNWARD PIPING - MAKING OPENINGS

- During horizontal or downward piping, use a knife to cut openings as shown in figure. Then smoothen the edges of openings with a file.

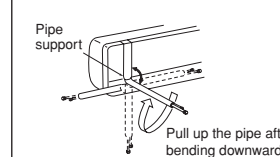

- Transform the piping while holding down the lower portion of pipe-support by hand.

INSTALLATION OF COOLANT PIPES AFTER CONNECTION

- The coolant pipes should be adjusted to fit into the hole on the wall and then ready for further connection.
- The terminals of 2 connected pipes must be covered with insulator used for terminal connection.
- Connect the power cord.
- After adjustment, fit the power cord and pipes into the space available under the indoor unit.

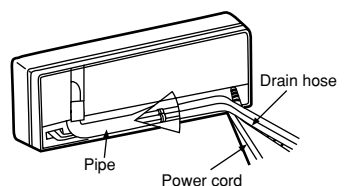

CAUTION

The rubber strap used for fixing the insulator should not be tied with great force. Otherwise, this will damage heat insulation and causes water condensation.

THE CONNECTION OF COOLANT PIPE DURING THE INSTALLATION OF INDOOR UNIT

Preparation To Install Coolant Pipes

- Coolant pipes and power cord must be tied together.

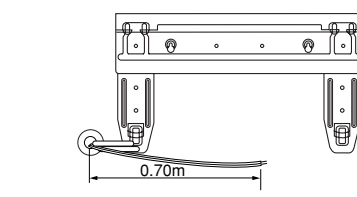

CAUTION

Please fix in the plastic core after flaring to avoid plastic chips entering the pipes.

Installation

Hang the indoor unit onto the mounting plate. Use the temporary stand at the back of the indoor unit to push its lower part 15cm forwards.

- Place the drain hose through the hole on the wall.
- Insulate the connecting portion of coolant pipe with insulator.
- Connect the power cord.
- After adjustment, the power cord and coolant pipes are placed into the space available under the indoor unit.
- The projection of indoor unit must hook to the mounting plate.

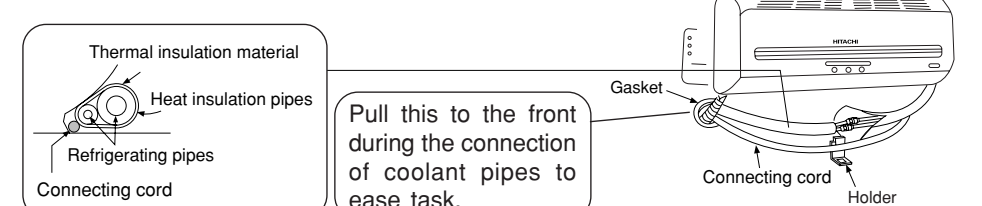

3 Installation of Drain Hose

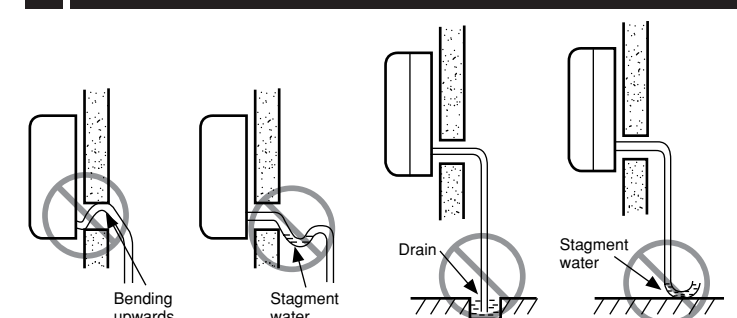

CAUTION

Be sure that the drain hose is not loosely connected or bent.

You are free to choose the side (left or right) for the installation of drain hose. Please ensure the smooth flow of condensed water of the indoor unit during installation. (Carelessness may result in water leakage.)

- Please mount the outdoor unit on stable ground to prevent vibration and increase of noise level.
- Decide the location for piping after sorting out the different types of pipe available.

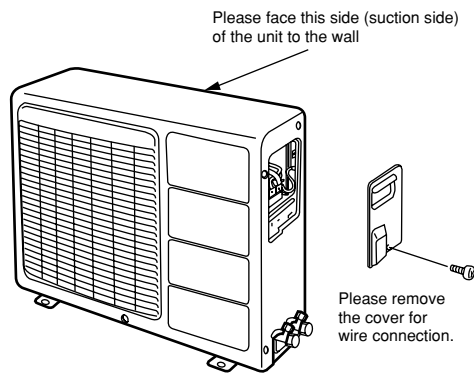

Procedure to remove the cover of wiring terminals

- Remove the screw (1 piece).
- Hold the projected part at the lower left of the cover and push the cover upwards to remove it.
- To close the cover, insert the upper part of the cover into the body of outdoor unit, then be sure that the hook below the cover is plugged in before screwing.

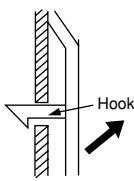

1 Preparation of Pipe

- Use a pipe cutter to cut the copper pipe.

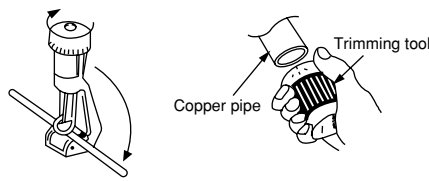

CAUTION

- Jagged edge will cause leakage.
- Point the side to be trimmed downwards during trimming to prevent copper chips from entering the pipe.
- Before flaring, please put on the hexagon screw cap.



Outer Diameter (ø)	A (mm)	
	Imperial flaring tool	Rigid flaring tool
6.35 (1/4")	0.8 - 1.5	0 - 0.5
12.7 (1/2")	1.0 - 2.0	0 - 1.0

2 Pipe Connection

- Please be careful when bending the copper pipe.
- Applied frozen grease to the connection points and then screw in manually. After that, use a torque wrench to tighten the connection.

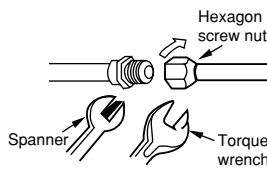

	Outer diameter of pipe	Torque N.m (kgf • cm)
Small diameter side	6.35 (1/4")	13.7 - 18.6 (140 - 190)
Big diameter side	12.7 (1/2")	44.1 - 53.9 (450 - 550)
Valve head cap		19.6 - 24.5 (200 - 250)
Valve core cap		12.3 - 15.7 (125 - 160)

3 Removal Of Air From The Pipe And Gas Leakage Inspection

Procedures of using Vacuum Pump for Air Removal

- 1 As shown in figure on the right, remove the cap of valve head and valve core and then connect them to the vacuum pump and sub-division valve.
- 2 Fully tighten the "Hi" shuttle of the sub-division valve and completely unscrew the "Lo" shuttle. Run the vacuum pump for about 10-15 minutes, then completely tighten the "Lo" shuttle and switch off the vacuum pump.
- 3 Completely unscrew the spindle of the service valve (at 2 places) in anti-clockwise direction to allow the flow of coolant (using Allen key).
- 4 Remove the connection pipe and tighten the cap of valve head. The task is then completed.

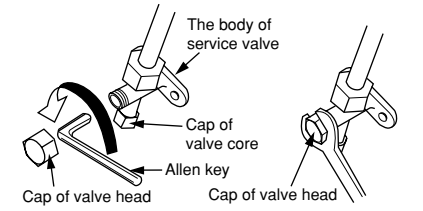
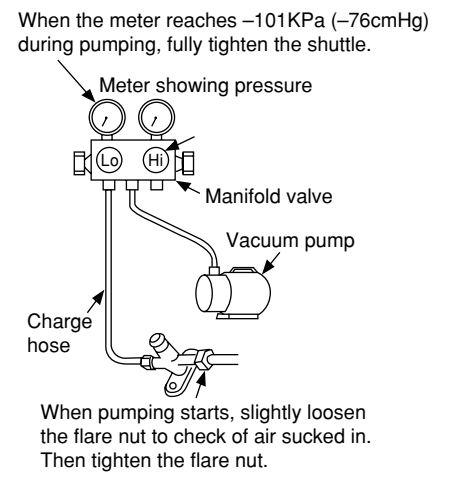

Gas Leakage Inspection

Please use gas leakage detector to check if leakage occurs at the connection of hexagon screw nut as shown on the right.

If gas leakage occurs, further tighten the connection to stop leakage.

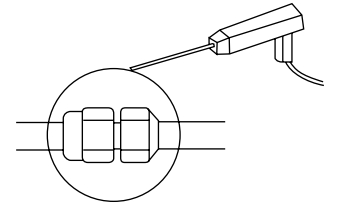

WARNING • THIS APPLIANCE MUST BE EARTHED.

Power supply shall be connected at the rated voltage, otherwise the unit will be broken or could not reach the specified capacity.

Procedures of Wiring

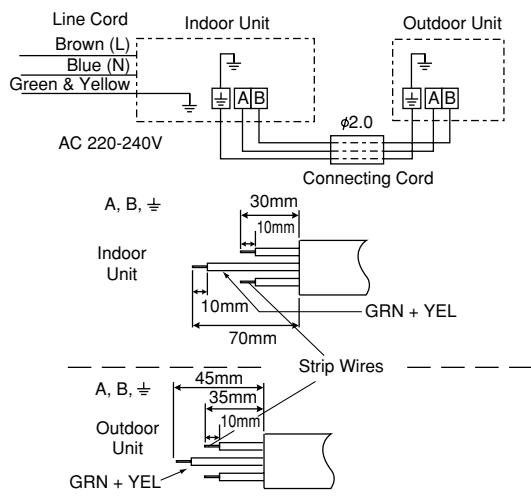

Detail of cutting the connecting cord

To remove the connecting wires for the indoor unit, please remove the low cover panel in front of the unit.

WARNING

- The naked part of the wire core should be 14 mm and the insulated part of the wire must be pushed into the terminal for 3 - 4 mm. Then try to pull the individual wire to check if the contact is tight. Improper insertion may burn the terminal.
- Be sure to use only wire specified for the use of air-conditioner.
- Please refer to the installation manual for wire connection and the wiring technique should meet the standards of electrical installation.
- There is a AC voltage drop between the AB terminals if the power is on. Therefore, be sure to remove the plug from its socket.

Wiring Of The Indoor Unit

(1) Wiring cover's removal sequence

- Pull the hooks at the locations marked (1) & (2) on the air chamber bottom cover located at the lower right hand corner of the unit's front cabinet, to remove the air chamber bottom cover
- Unscrew the fastening screws and remove of the wiring cover

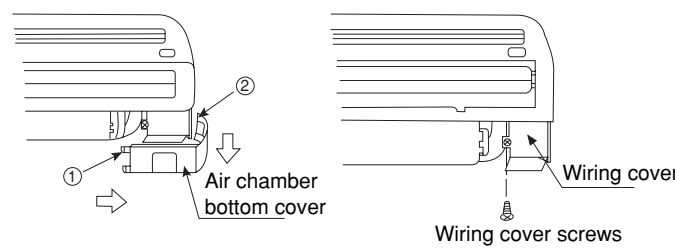

(2) Wiring sequence

- Insert separately and firmly fasten the wires of different colors into the specific terminal slots as shown in illustration 1 & 2. (tightening strength: 5 kgf.cm)

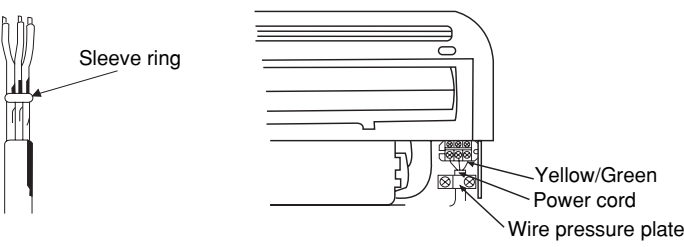

illustration 1

- Must connect the electrical cable's yellow/green wires to the terminals that are marked with ⊕
- Secure firmly the connecting electrical cables with the wire pressure plates located at the air chamber's bottom area, to prevent the wires from detaching under stress
- After completing the connection of the electrical cables, install the wiring cover as per illustration 2

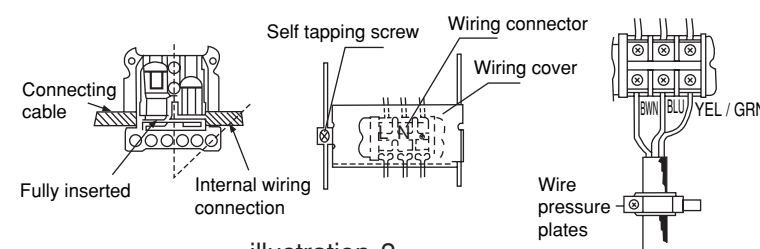
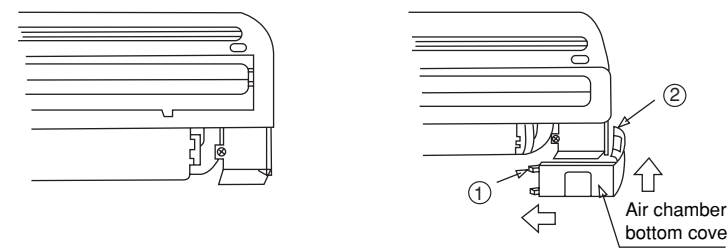

illustration 2

(3) Installation sequence for wiring cover and air chamber's right hand cover

- Fastener the wiring cover with screws
- Push the hooks at the locations marked (1) & (2) on the air chamber bottom cover located at the lower right hand corner of the unit's front cabinet, to re-install the air chamber bottom cover



Wiring Of The Outdoor Unit

- Please remove the side cover for wire connection.

WARNING

- You may not be able to close the side cover due to the connecting cord, under such situation, please press against the wall of side cover to fix it.
- Be sure that the hooks (2 places) are plugged in. Otherwise, water leakage may occur and this causes short circuit or faults.

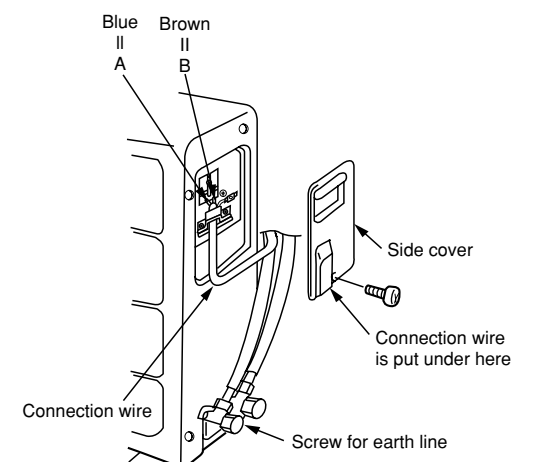

Use 15A time delay FUSE

1 Insulation And Maintenance Of Pipe Connection

- The connected terminals should be completely sealed with heat insulator and then tied up with rubber strap.
- Please tie the pipe and power line together with plastic tape as shown in the figure of installation of both the indoor and outdoor units. Then fix their position with holders.
- To enhance the heat insulation and to prevent water condensation, please cover the outdoor part of the drain hose and pipe with insulation pipe.
- Completely seal any gap with putty.

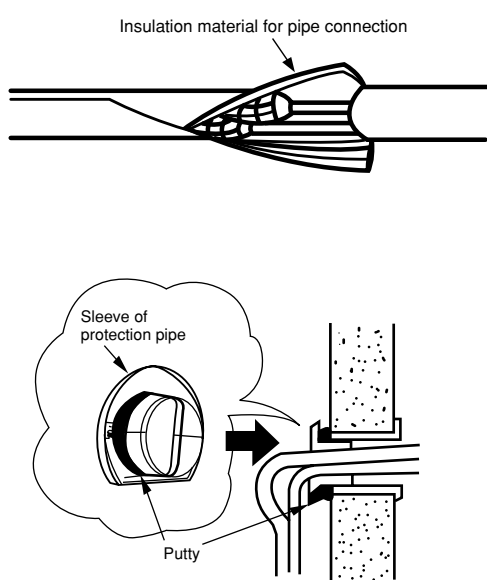

2 Installation Of Remote Control

- The remote controller can be placed in its holder which is fixed on wall or beam.
- To operate the remote controller at its holder, please ensure that the unit can receive signal transmitted from the controller at the place where the holder is to be fixed. The unit will beep when signal is received from the remote controller. The signal transmission is weakened by the fluorescent light. Therefore, during the installation of the remote control holder, please switch on the light, even during day time, to determine the mounting location of the holder.

The controller should be insert from top into bottom side of the holder as shown in figure below.

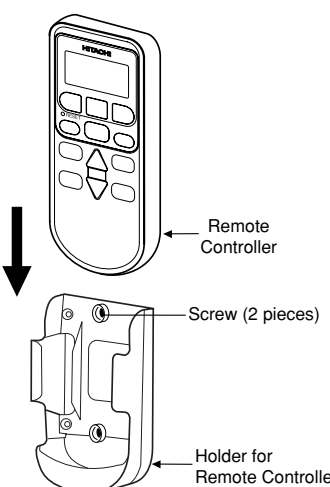

3 Earth Line And Circuit Breaker

CAUTION

- The earth line terminal of the outdoor unit is below the service valve.
- To avoid short circuit, it is necessary to install circuit breaker depending on the mounting location of the unit.
- Do not place earth line near the following objects:
 - (1) Water pipe
 - (2) Gas pipe - There is danger of catching fire.
 - (3) The earth line of lightning conductor and telephone - short circuit may occur during lightning.

4 Power Source And Operation Test

Power Source

WARNING

- Do not alter the plug of power cord. Do not make extension to the power cord.

CAUTION

- Please use a new socket. Accident may occur due to the use of old socket because of poor contact.
- Please plug in and then remove the plug for 2 - 3 times. This is to ensure that the plug is completely plugged into the socket.
- Keep additional length for the power cord and do not render the plug under external force as this may cause poor contact.
- Do not fix the power cord with U-shape nail.

Operation Test

- Please ensure that the air conditioner is in normal operating condition during the operation test.
- Explain to your customer the proper operation procedures as described in the user's manual.

How to Remove the Front Cover

- Open the cover (1) and remove the screw.
- Remove the filter, release the axis by pulling the center portion of front cover in the direction of arrow (2).
- Push vertical air deflector handle to the right or left side.
- After raise the front cover from bottom side as (3), release the front cover by pull the right or left sides as (4).

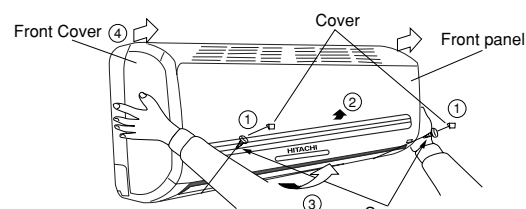

How to Install the Front Cover

- Insert the two hooks (5) at the upper side certainly.
- Open Front Panel, push the center down in the direction of the arrow to insert the axis at the center of the front cover into the hook at the outlet frame.

