

# FOR SERVICE PERSONNEL ONLY

**HITACHI**  
Inspire the Next

## SPLIT UNIT AIR CONDITIONER INSTALLATION MANUAL

**Indoor Unit**

**RAS-30CHP6**

**Outdoor Unit**

**RAC-30CHP6**

- Carefully read through the procedures of proper installation before starting installation work.
- The sales agent should inform customers regarding the correct operation of installation.

### Tools Needed For Installation Work

- $\oplus$   $\ominus$  Screwdriver • Measuring Tape • Knife
- Saw •  $\varnothing$ 80mm Power Drill • Hexagonal Wrench Key ( $\boxtimes$  4mm) • Wrench (14, 17, 19, 22, 24, 27mm)
- Gas Leakage Detector • Pipe Cutter • Putty
- Vinyl Tape • Pliers • Flare Tool

### SAFETY PRECAUTION

- Read the safety precautions carefully before operating the unit.
  - The contents of this section are vital to ensure safety. Please pay special attention to the following sign.
  - WARNING** ..... Incorrect methods of installation may cause death or serious injury.
  - CAUTION** ..... Improper installation may result in serious consequence.
- Be sure that the unit operates in proper condition after installation. Explain to customer the proper way of operating the unit as described in the user's guide.

### WARNING

- Please request your sales agent or qualified technician to install your unit. Water leakage, short circuit or fire may occur if you do the installation work yourself.
- Please observe the instructions stated in the installation manual during the process of installation. Improper installation may cause water leakage, electric shock and fire.
- Make sure that the units are mounted at locations which are able to provide full support to the weight of the units. If not, the units may collapse and impose danger.
- Observe the rules and regulations of the electrical installation and the methods described in the installation manual when dealing with the electrical work. Use power cables approved by the authorities of your country.
- Be sure to use the specified wire for connecting the indoor and outdoor units. Please ensure that the connections are tight after the conductors of the wire are inserted into the terminals. Improper insertion and loose contact may cause over-heating and fire.
- Please use the specified components for installation work. Otherwise, the units may collapse or water leakage, electric shock and fire may occur.
- Be sure to use the specified piping set for R22. Otherwise, this may result in broken copper pipes or faults.
- When installing or removing an air conditioner, do not allow air or moisture to remain in the refrigeration cycle. Otherwise, pressure in the refrigeration cycle may become abnormally high so that a rupture may be caused.
- Be sure to ventilate fully if a refrigerant gas leak while at work. If the refrigerant gas comes into contact with fire, a poisonous gas may occur.
- After completion of installation work, check to make sure that there is no refrigeration gas leakage. If the refrigerant gas leaks into the room, coming into contact with fire in the fan-driven heater, space heater, etc., a poisonous gas may occur.
- Unauthorized modifications to the air conditioner may be dangerous. If a breakdown occurs please call a qualified air conditioner technician or electrician. Improper repairs may result in water leakage, electric shock and fire, etc.

### CAUTION

- A circuit breaker or fuse (30A time delay) must be installed. Without a circuit breaker or fuse the danger of electric shock exists. A main switch with a contact gap of more than 3mm has to be installed in the power supply line to the outdoor unit.
- Do not install the unit near a location where there is flammable gas. The outdoor unit may catch fire if flammable gas leaks around it.
- Please ensure smooth flow of water when installing the drain hose.
- Piping shall be suitable supported with a maximum spacing of 1m between the supports.

### THE CHOICE OF MOUNTING SITE (Please note the following matters and obtain permission from customer before installation).

#### WARNING

- The unit should be mounted at stable, non-vibratory location which can provide full support to the unit.

#### CAUTION

- No nearby heat source and no obstruction near the air outlet is allowed.
- The clearance distances from top, right and left are specified in figure below.
- The location must be convenient for water drainage and pipe connection with the Outdoor unit.
- To avoid interference from noise please place the unit and its remote controller at least 1m from the radio, television and inverter type fluorescent lamp.
- To avoid any error in signal transmission from the remote controller, please put the controller far away from high-frequency machines and high-power wireless systems.
- The installation height of indoor unit must be 2.3m or more.

#### WARNING

- The Outdoor unit must be mounted at a location which can support heavy weight. Otherwise, noise and vibration will increase.

#### CAUTION

- Do not expose the unit under direct sunshine or rain. Besides, ventilation must be good and clear of obstruction.
- The air blown out of the unit should not point directly to animals or plants.
- The clearances of the unit from top, left, right and front are specified in figure below. At least 3 of the above sides must be open air.
- Be sure that the hot air blown out of the unit and noise do not disturb the neighbourhood.
- Do not install at a location where there is flammable gas, steam, oil and smoke.
- The location must be convenient for water drainage.
- Place the Outdoor unit and its connecting cord at least 1m away from the antenna or signal line of television, radio or telephone. This is to avoid noise interference.
- Do not install outdoor unit facing strong wind direction. It may damage the fan motor.

### Names of Indoor Components

No.	Item	Qty
①	Hanger	1
②	Screw for Hanger (4.1 x 32)	6
③	Holder for Remote Controller	1
④	AAA Size Battery	2
⑤	Screw for holder of Remote Controller (3.1 x 16)	2
⑥	Insulation pipe	1
⑦	Remote Controller	1
⑧	Purifying Filter	1

### The Length of Indoor Unit Connecting Cord

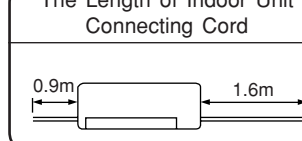

### Direction of Piping

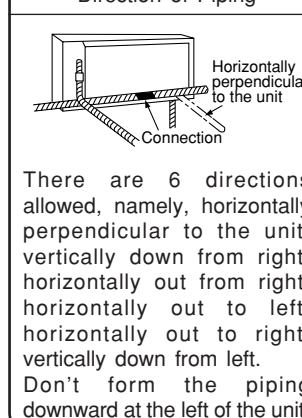

### Dimension of Mounting Stand of the Outdoor Unit

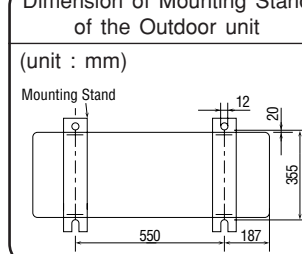

### Names of Outdoor Components

No.	Item	Qty
⑨	Bush	1
⑩	Bush	3
⑪	Drain Pipe	1

### Figure showing the Installation of Indoor and Outdoor Unit.

#### CAUTION

In case the pipe length is more than 8m, add refrigerant R22 at 40 gram per every meter exceeds. However, pipe length shall not exceed 30m.

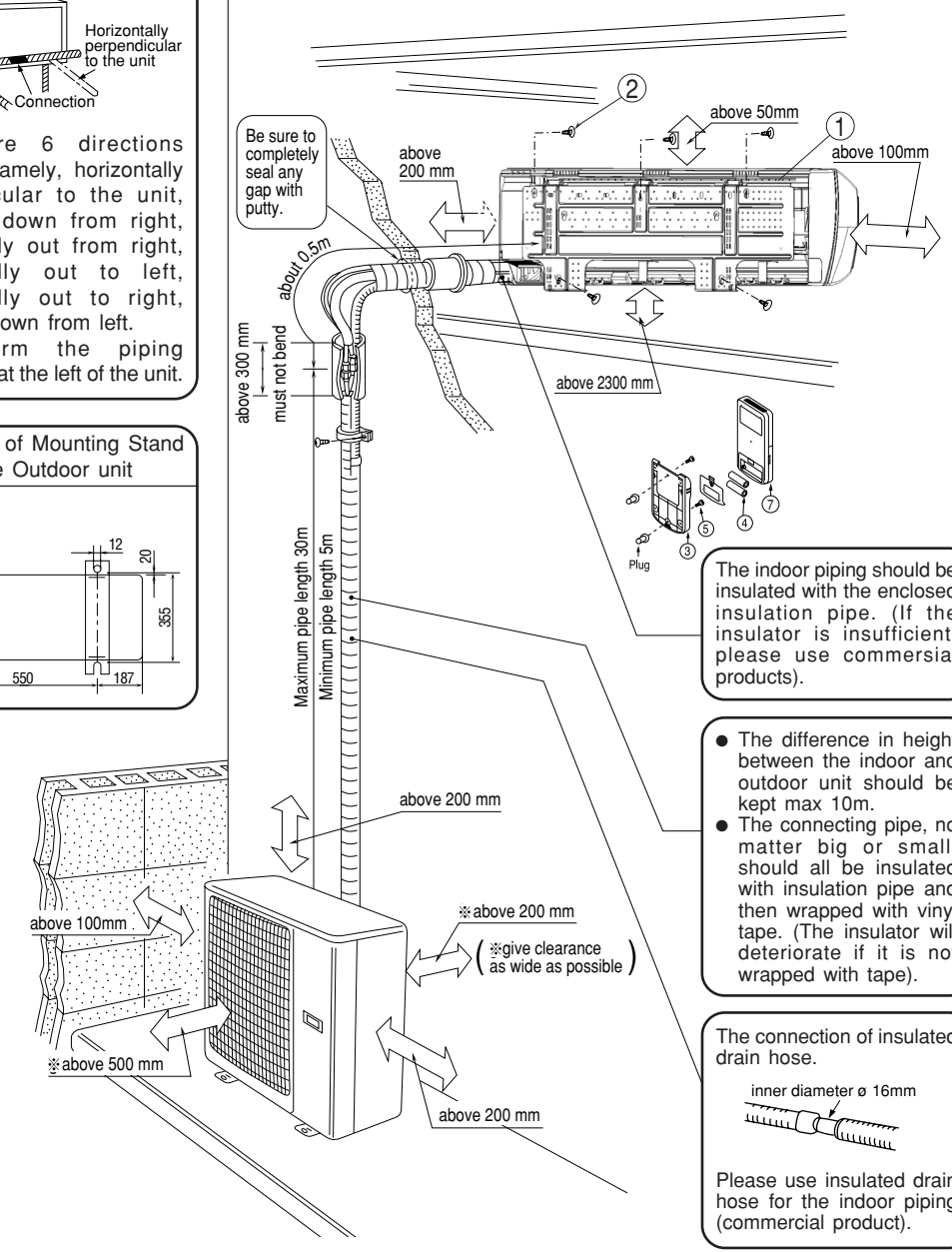

### 1 Installation of Hanger, Wall Penetration and Installation of Protection Pipe

#### CAUTION

- The draining of the water container inside the indoor unit can be done from the left. Therefore the hanger must be fixed horizontally or slightly tilted towards the side of drain hose. Otherwise, condensed water may overflow the water container.

#### Direct Mounting On The Wall

- Please use hidden beams in the wall to hold the hanger.

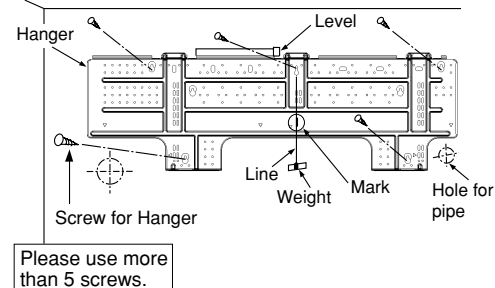
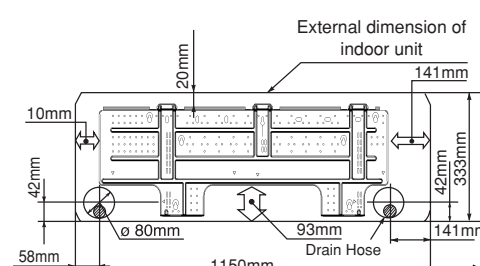

#### Procedures of Installation and Precautions

- Procedures to fix the hanger.
  1. Drill holes on wall. (As shown below)
  2. Push plug into the holes. (As shown below)
  3. Fix the hanger on wall with 4.1 x 32 screw (As shown in figure below)

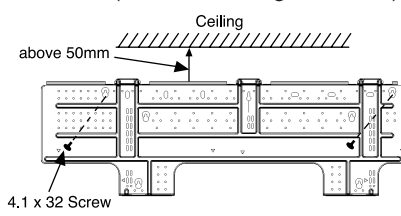
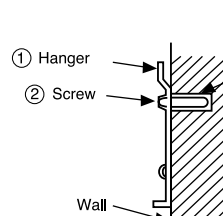
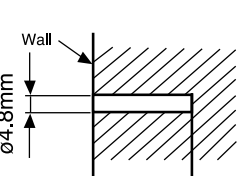

- Procedures to fix the holder of remote control.
  1. Drill holes on wall. (As shown below)
  2. Push plug into the holes. (As shown below)

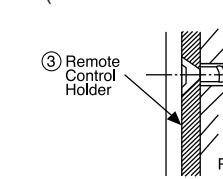
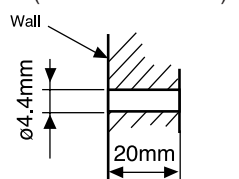

#### Wall Penetration and Installation of Protection Pipe

- Drill a  $\varnothing$  80mm hole on wall which is slightly tilted towards the outdoor side. Drill the wall at a small angle.
- Cut the protection pipe according to the wall thickness.
- Empty gap in the sleeve of protection pipe should be completely sealed with putty to avoid dripping of rain water into the room.

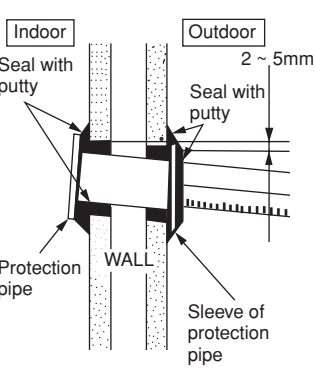

#### WARNING

Be sure that the wire is not in contact with any metal in the wall. Please use the protection pipe as wire passing through the hollow part of the wall so as to prevent the possibility of damaged by mouse. Unless it seals completely, any air with high humidity flows from outdoor and any dew may drop.

### 2 Installation of the Indoor Unit

#### DIRECTLY BACKWARD AND DOWNWARD PIPING

##### Preparation

- Connect connecting cord.
- Pull out the pipe, connecting cord and drain hose.
- Arrange a drain hose in lowest part of a wall hole.

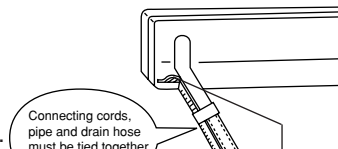

##### Installation

- The upper part of the Indoor unit is hanged on the hanger.
- The projection at the lower part of the Indoor unit is hooked onto the hanger.

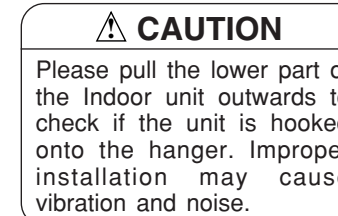
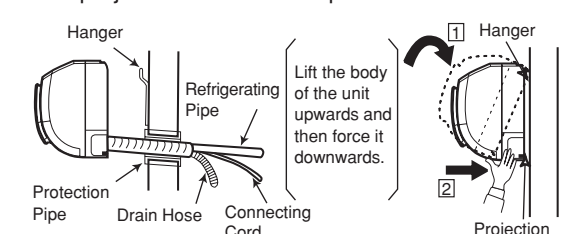

#### CAUTION

Please pull the lower part of the Indoor unit outwards to check if the unit is hooked onto the hanger. Improper installation may cause vibration and noise.

#### HOW TO REMOVE INDOOR UNIT FROM HANGER

- Push up PUSH section on the bottom of indoor unit, then claws are released from hanger. (Indicated by 2 arrows in the drawing on the right.)

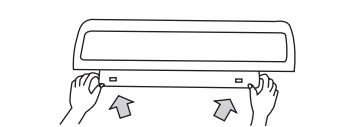

#### HORIZONTAL PIPING

##### Preparation

##### Change of Drain Hose and Installation Procedures.

- Exchange the location of drain hose and drain cap during horizontal piping as shown in figure below. Be sure to plug in the drain hose until the insulating material folds upon itself.
- Please use pliers to pull out the drain cap. (This is an easier way to remove the drain cap.)

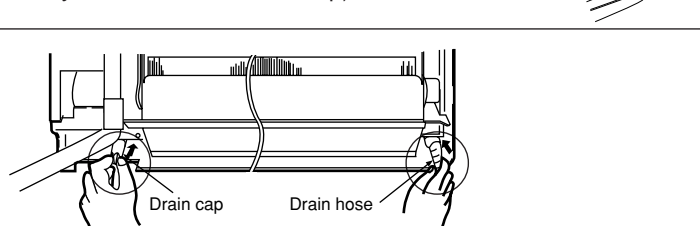

#### CAUTION

Condensed water may leak out if not inserted properly.

#### HORIZONTAL & DOWNWARD PIPING - MAKING OPENINGS

- During horizontal or downward piping, use a knife to cut openings as shown in figure. Then smoothen the edges of openings with a file.

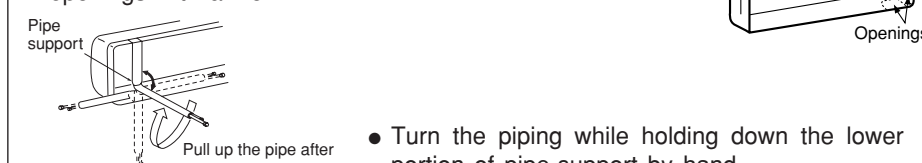

### INSTALLATION OF REFRIGERATING PIPES AFTER CONNECTION

- The refrigerating pipes should be adjusted to fit into the hole on the wall and then ready for further connection.
- The terminals of 2 connected pipes must be covered with insulator used for terminal connection. Then the pipes are wrapped with insulation pipe.
- Connect the connecting cord after removing electrical cover. (Refer to "CONNECTION OF POWER CORD")
- After adjustment, fit the connecting cord and pipes into the space available under the indoor unit. Use holder to hold them tight.

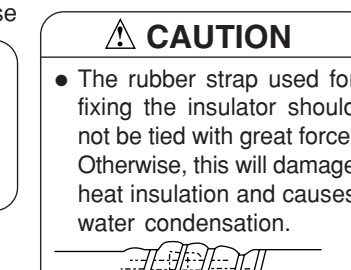
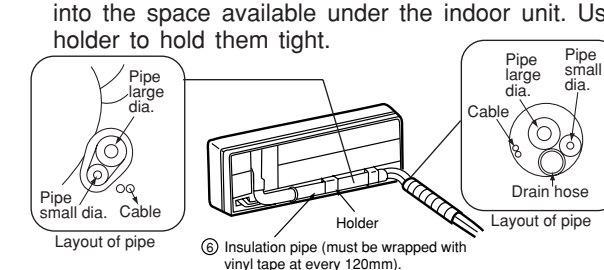
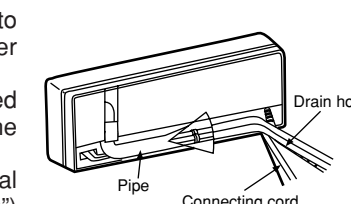

#### CAUTION

The rubber strap used for fixing the insulator should not be tied with great force. Otherwise, this will damage heat insulation and causes water condensation.

### THE CONNECTION OF REFRIGERATING PIPE DURING THE INSTALLATION OF INDOOR UNIT

#### Preparation To Install Refrigerating Pipes

- The refrigerating pipes and connecting cord transform and are attached.
- The end of the refrigerating pipes are at locations marked with "▽" symbol.

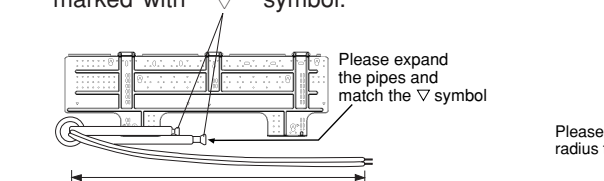

#### CAUTION

Please fix in the plastic core after flaring to avoid plastic chips entering the pipes.

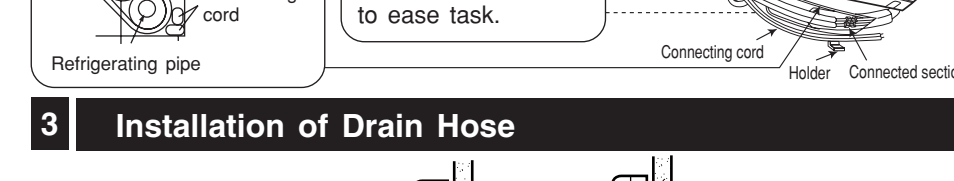
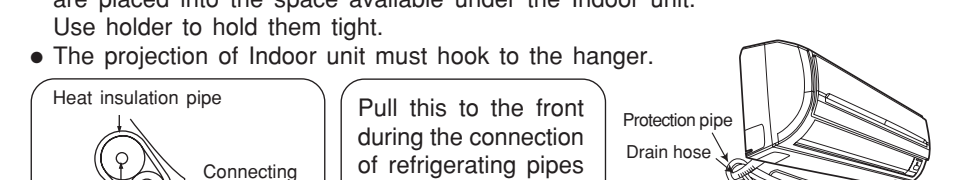
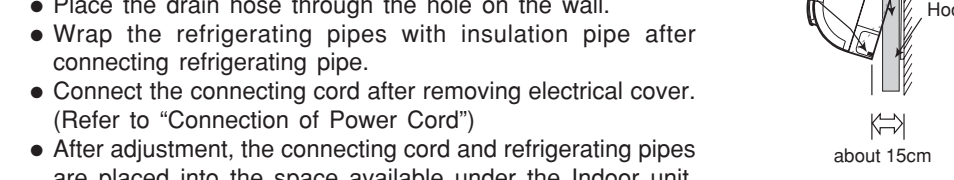
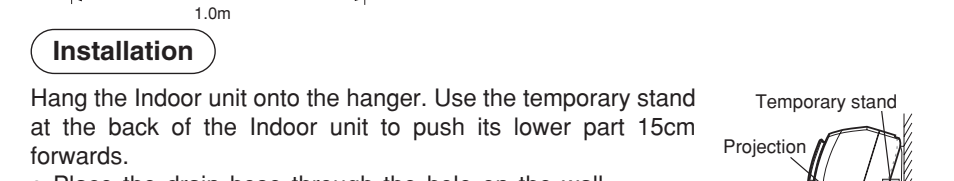

### 3 Installation of Drain Hose

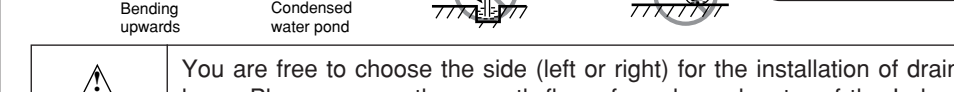
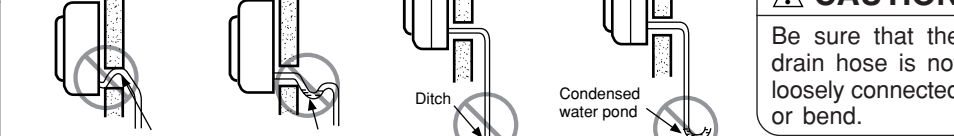

#### CAUTION

You are free to choose the side (left or right) for the installation of drain hose. Please ensure the smooth flow of condensed water of the Indoor unit during installation. (Carelessness may result in water leakage.)

### 1 Installation of Outdoor Unit

- Mount the outdoor unit on stable ground to prevent vibration and increase of noise level.
- Remove 4 screws that fixed the cover and pull the cover downward to remove it.
- Decide the location for piping after sorting out the different types of pipe available.

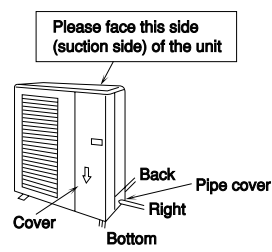

#### Preparation to Install Refrigerating Pipe

- Refrigerating pipe can be installed in 3 directions as in figure. Make hole at the refrigerating pipe cover and cabinet where the pipe passes. After removing the refrigerating pipe cover from unit, remove by using cutter as following the guideline at the back surface or using screw driver. Smoothen the edge using cutter etc.
- Place the refrigerating pipe cover to prevent from rain etc. to penetrate cabinet. Assure that no gap at where the pipe passes.
- Bend pipe at smallest R as possible.

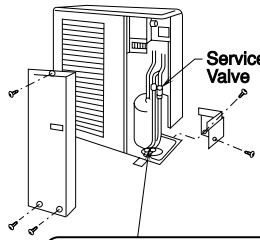

**CAUTION**  
Arrange the pipes so as not to touch the internal pipe or sound proof material.

#### CONDENSED WATER DISPOSAL OF OUTDOOR UNIT

- There are holes on the base of Outdoor unit for condensed water to exhaust.
- In order to flow condensed water to the drain, the unit is installed on a stand or a block so that the unit is 100mm above the ground as shown figure. Join the drain pipe to one hole.
- At first insert one portion of the hook to the base (Portion A), then pull the drain pipe in the direction shown by the arrow while inserting the hook into the base. After installation, check whether the drain pipe cling to the base firmly.

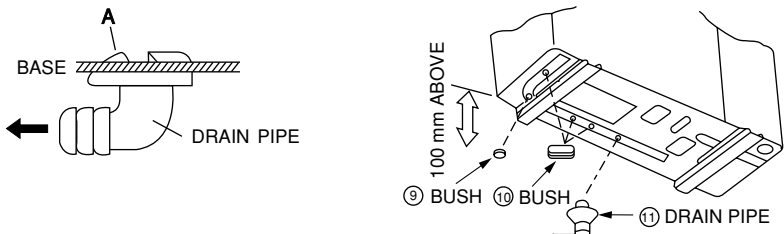

- When using in cold region, etc. In cold region with severe cold climate and heavy snow, water discharged from heat exchanger freeze on the base surface and this may affect drainage. In such a region, remove bush on the bottom face of outdoor unit for better drainage. When using drainpipe, consult our dealer.

### 1 Preparation of Pipe

- Use a pipe cutter to cut the copper pipe.

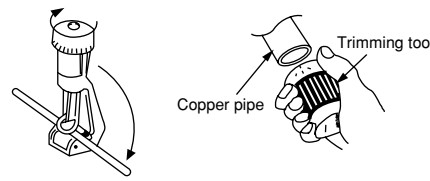

#### CAUTION

- Jagged edge will cause leakage.
- Point the side to be trimmed downwards during trimming to prevent copper chips from entering the pipe.
- Before flaring, please put on the flare nut.



- Please use exclusive tool

Outer Diameter (mm)	A (mm)	
	Imperial flaring tool	Rigid flaring tool
6.35	0.8 ~ 1.5mm	0 ~ 0.5mm
15.88	1.0 ~ 2.0mm	0 ~ 1.0mm

### 2 Pipe Connection

#### CAUTION

In case of removing flare nut of an Indoor unit, first remove a nut of small diameter side, or a seal cap of big diameter side will fly out. Prevent water from entering into the piping when working.

- Please be careful when bending the copper pipe.
- Screw in manually while adjusting the center. After that, use of torque wrench to tighten the connection.

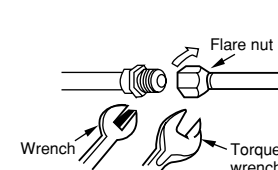

	Outer dia. of pipe	Torque N·m (kgf · cm)
Small dia. side	6.35 (1/4")	13.7 - 18.6 (140 - 190)
Large dia. side	15.88 (5/8")	49 - 58.8 (500 - 600)
Valve head cap	Small dia. side 6.35 (1/4") Large dia. side 15.88 (5/8")	19.0 - 21.0 (194 - 214) 29.0 - 31.0 (296 - 316)
Valve core cap		9.0 (92)

### 3 Removal Of Air From The Pipe And Gas Leakage Inspection

#### Procedures of using Vacuum Pump for Air Removal

- As shown in right figure, remove the cap of valve core. Then, connect the charge hose. Remove the cap of valve head. Connect the vacuum pump adapter to the vacuum pump and connect the charge hose to the adapter.

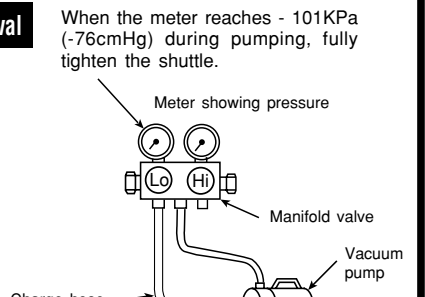

- Fully tighten the "Hi" shuttle of the manifold valve and completely unscrew the "Lo" shuttle. Run the vacuum pump for about 10-15 minutes, then completely tighten the "Lo" shuttle and switch off the vacuum pump.

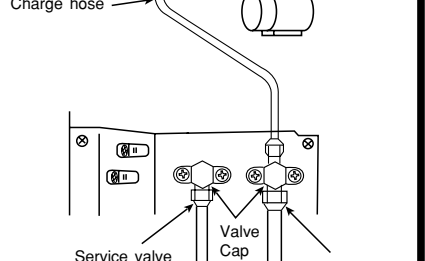

- Completely unscrew the spindle of the service valve (at 2 places) in anti-clockwise direction to allow the flow of coolant (using Hexagonal Wrench key).

When pumping starts, slightly loosen the hexagon screw nut to check of air sucked in. Then tighten the flare nut.

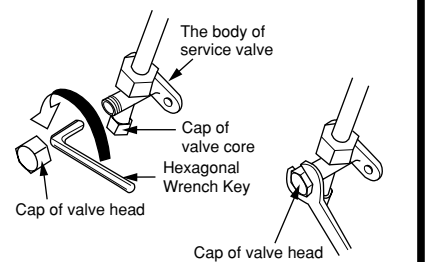

- Remove the charge hose and tighten the cap of valve head. Check the cap's periphery if there is any gas leakage. The task is then completed.

#### Gas Leakage Inspection

Please use gas leakage detector to check if leakage occurs at the connection of Flare nut as shown on the right.

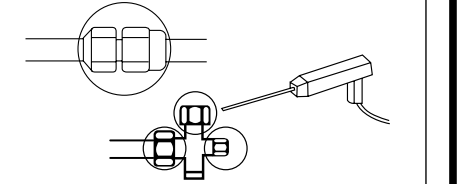

If gas leakage occurs, further tighten the connection to stop leakage.

### WARNING THIS APPLIANCE MUST BE EARTHED.

#### Procedures of Wiring

In case that power is supplied from Indoor Unit

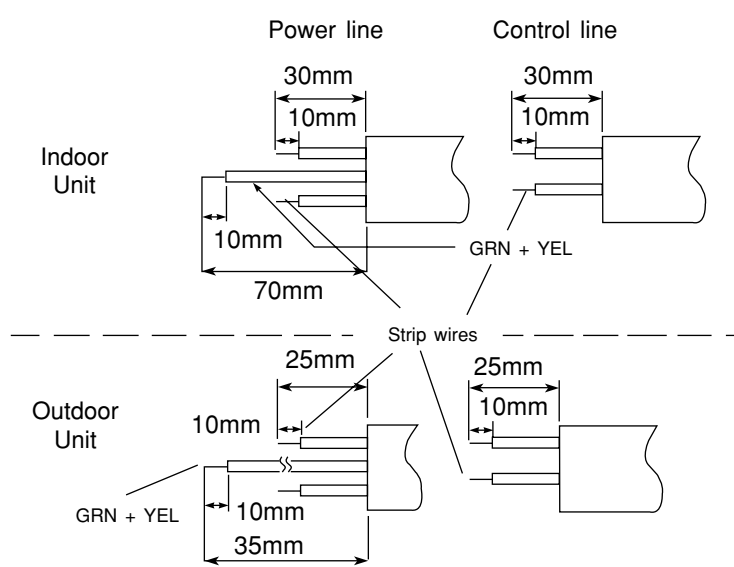
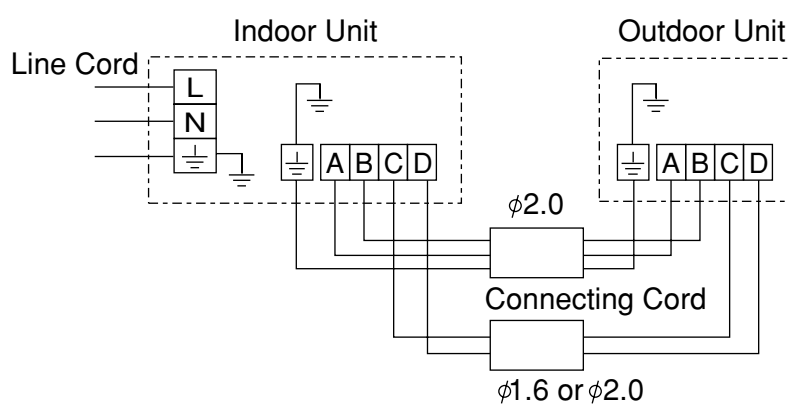

#### WARNING

- The naked part of the wire core should be 10 mm and fix it to the terminal tightly. Then try to pull the individual wire to check if the contact is tight. Improper insertion may burn the terminal.
- Be sure to use only power cables approved from the authorities in your country. For example in Germany: Cable type: NYM 3x1.5mm<sup>2</sup>, (fuse = 30A time delay)
- Please refer to the installation manual for wire connection to the terminals of the units. The cabling must meet the standards of electrical installation.
- There is a AC voltage of 220-240V between the L and N terminals. Therefore, before servicing, be sure to remove the plug from the AC outlet or switch off the main switch.

#### Wiring Of The Indoor Unit

- For wire connection of the Indoor unit, you need to remove front panel and electrical cover.

Method to remove front panel

- Refer to "FINAL STAGE OF INSTALLATION - How to Remove The Front Cover".

#### Method to remove electrical cover

- Remove the screw and electrical cover.
- Insert the connecting cord (A, B, C, D) from the bottom of unit.
- Fixed the wire to terminal wires firmly as shown in figure at right side.

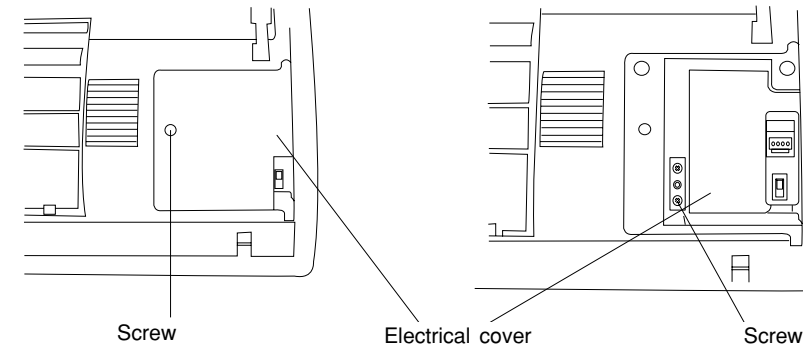

#### Wiring of The Outdoor Unit

- Please remove the side cover for wire connection.

#### WARNING

- If you cannot attach the side cover due to the connecting cord, press the connecting cord in direction to the front panel to fix it.
- Be sure that the hooks of the side cover is fixed in certainly. Otherwise water leakage may occur and this causes short circuit or faults.
- The connecting cord should not touch to service valve and pipes. (It becomes high temperature in heating operation.)

#### Checking for the electric source and the voltage range

- Before installation, the power source must be checked and necessary wiring work must be completed. To make the wiring capacity proper, use the wire gauges list below for the lead-in from a pole transformer and for the wiring from a switch board of fuse box to the main switch and outdoor unit in consideration of the locked rotor current.

#### IMPORTANT

Cable length	Wire cross-section
up to 6m	1.5mm <sup>2</sup>
up to 15m	2.5mm <sup>2</sup>
up to 25m	4.0mm <sup>2</sup>

#### IMPORTANT

Fuse Capacity
30A time delay fuse

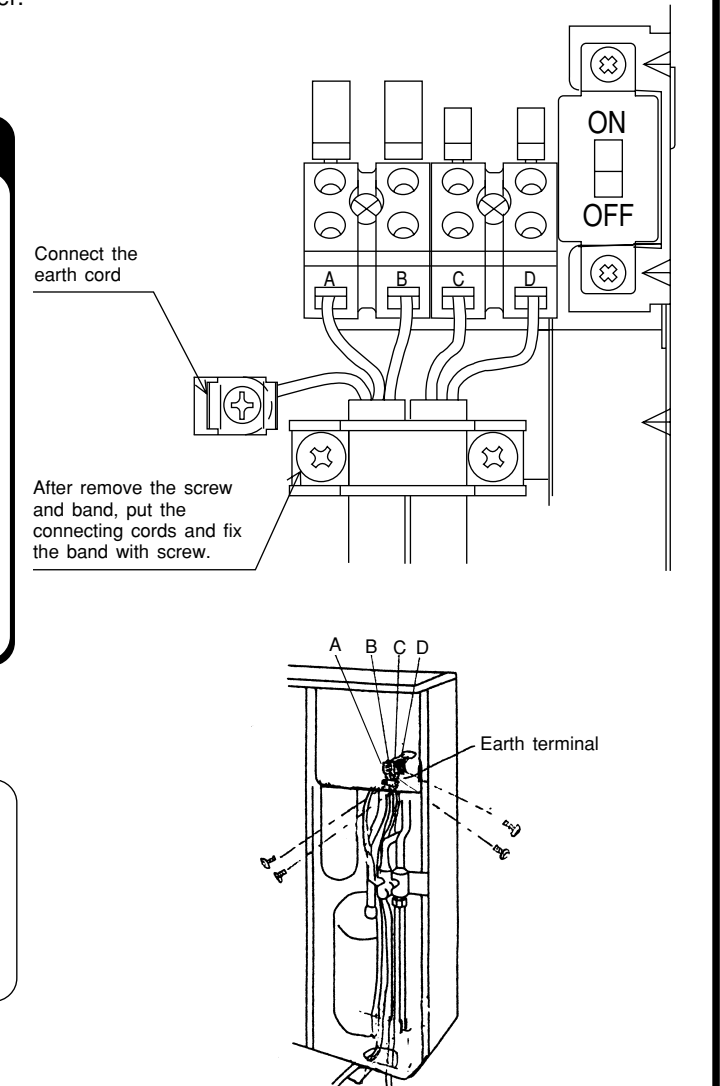

### 1 Insulation And Maintenance Of Pipe Connection

- The connected terminals should be completely sealed with heat insulator and then tied up with rubber strap.
- Please tie the pipe and power line together with vinyl tape as shown in the figure showing the installation of Indoor and Outdoor units. Then fix their position with holders.
- To enhance the heat insulation and to prevent water condensation, please cover the outdoor part of the drain hose and pipe with insulation pipe.
- Completely seal any gap with putty.

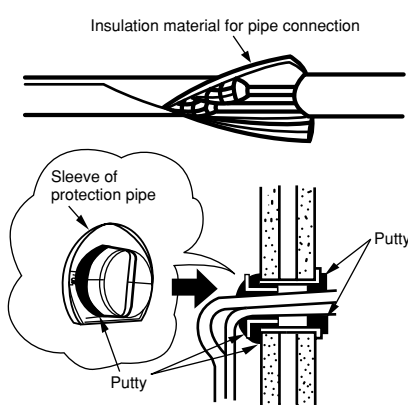

### 2 Installation Of Remote Controller

- The remote controller can be placed in its holder which is fixed on wall or beam.
- To operate the remote controller at its holder, please ensure that the unit can receive signal transmitted from the controller at the place where the holder is to be fixed. The unit will beep when signal is received from the remote controller. The signal transmission is weakened by the fluorescent light. Therefore, during the installation of the remote control holder, please switch on the light, even during day time, to determine the mounting location of the holder.

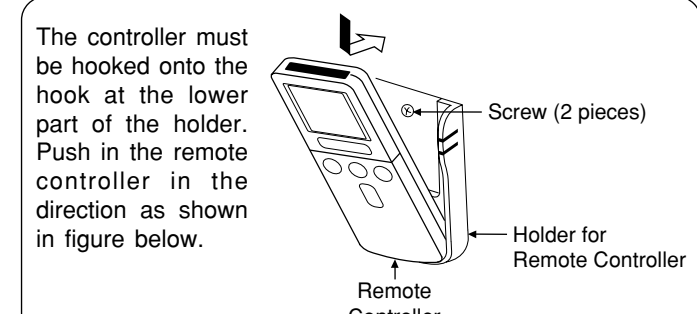

### 3 Power Source And Operation Test

#### Power Source

#### CAUTION

- Please use a new socket. Accident may occur due to the use of old socket because of poor contact.
- Please plug in and then remove the plug for 2 - 3 times. This is to ensure that the plug is completely plugged into the socket.
- Keep additional length for the power cord and do not render the plug under external force as this may cause poor contact.
- Do not fix the power cord with U-shape nail.

#### Operation Test

- Please ensure that the air conditioner is in normal operating condition during the operation test.
- Explain to your customer the proper operation procedures as described in the user's manual.

### How to Remove The Front Cover

- Open the front panel.

- Please remove and attach the front panel by both hands.

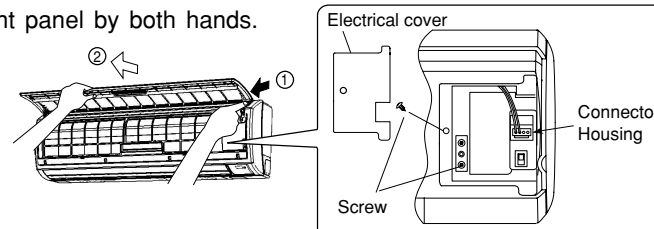

- After opening the front panel by both hands.
  - Undo the right arm while pushing it inside.
  - Slide the front panel to right as shown in figure. Then remove while pulling it to front.
  - Remove the screw and electrical cover, disconnect the wire connector from connector housing.

- Remove the filters.
- Remove the caps and screws at the lower portion of the front cover.

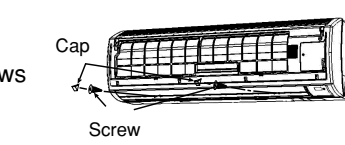

- Pull the front cover upward as far as the location where the lower portion of the front cover is on the deflector.

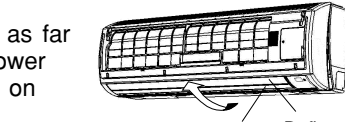

- Remove while pulling the front cover in direction to arrow as shown in figure to hold the both sides of front cover.

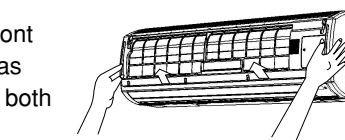

### How to Attach the Front Cover

- After covering the front cover to the unit, certainly hook at the upper portion (four places). Then, check that the drain pan is certainly attached. Push the front cover in the direction of arrow at the portion of hooks.

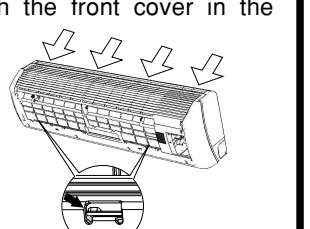

- Hook the front cover at lower portion to the drain pan and then fix them by screws and attach the caps.
- Connect the wire connector, fixed the screw and electrical cover.
- Attach the front panel.

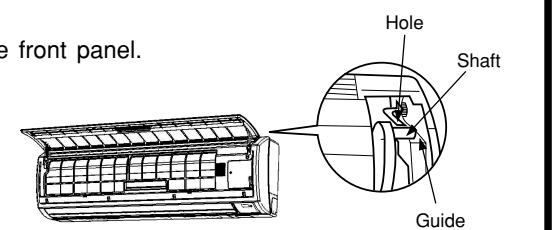

- Certainly insert the left shaft of the front panel to the hole of the front cover. Next insert the right shaft as same as the left.
- Attach the filters which are placed the surface written "FRONT" up.
- After attaching the filters, push the front panel at three arrow portion as shown in figure and close it.

