

HITACHI

Inspire the Next

SPLIT TYPE

INDOOR UNIT/OUTDOOR UNIT

MODEL

RAS-10C9/RAC-10C9
RAS-13C9/RAC-13C9

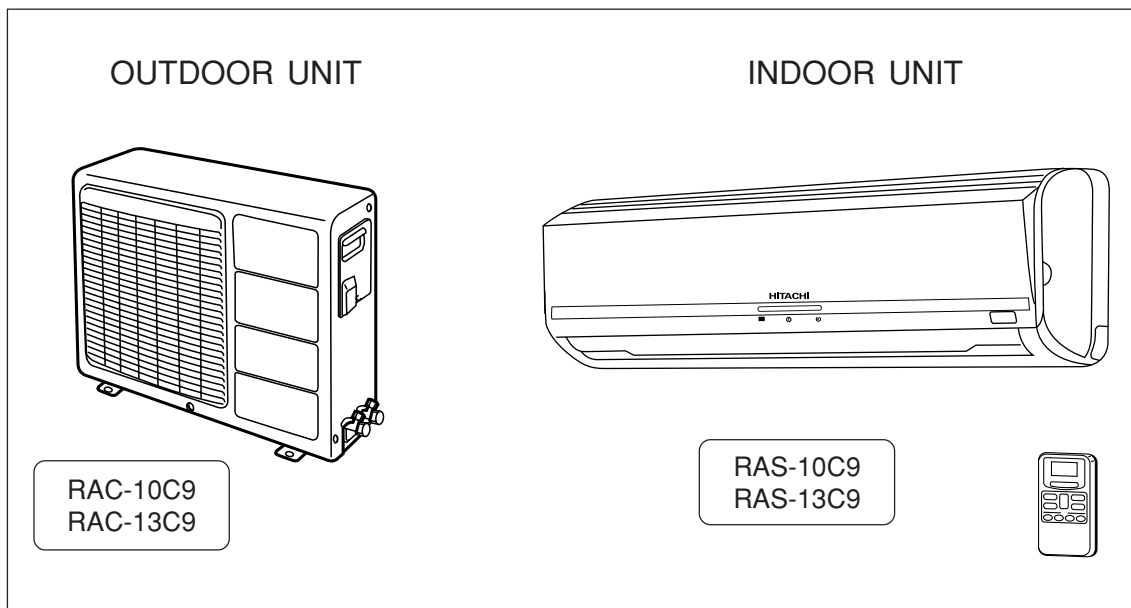

Instruction manual

To obtain the best performance and ensure years of trouble free use, please read this instruction manual completely.

Page 1~22

Arahan pengendalian



Untuk mendapatkan prestasi yang tinggi dan mengelakkan masalah untuk jangka masa yang lama, sila baca arahan ini sepenuhnya.

Muka surat 23~44







SAFETY PRECAUTION

- Please read the “Safety Precaution” carefully before operating the unit to ensure correct usage of the unit.
- Pay special attention to signs of “▲ Warning” and “▲ Caution”. The “Warning” section contains matters which, if not observed strictly, may cause death or serious injury. The “Caution” section contains matters which may result in serious consequences if not observed properly. Please observe all instructions strictly to ensure safety.
- The sign indicate the following meanings.



 Make sure to connect earth line.	 The sign in the figure indicates prohibition.
 Indicates the instructions that must be followed.	

- Please keep this manual after reading.





PRECAUTIONS DURING INSTALLATION

 WARNING	<ul style="list-style-type: none"> ● Do not reconstruct the unit. Water leakage, fault, short circuit or fire may occur if you reconstruct the unit by yourself. 	
	<ul style="list-style-type: none"> ● Please ask your sales agent or qualified technician for the installation of your unit. Water leakage, short circuit or fire may occur if you install the unit by yourself. 	
 CAUTION	<ul style="list-style-type: none"> ● Please use earth line. Do not place the earth line near water or gas pipes, lightning-conductor, or the earth line of telephone. Improper installation of earth line may cause electric shock. 	
	<ul style="list-style-type: none"> ● A circuit breaker should be installed depending on the mounting site of the unit. Without a circuit breaker, the danger of electric shock exists. 	
	<ul style="list-style-type: none"> ● Do not install near location where there is flammable gas. The outdoor unit may catch fire if flammable gas leaks around it. ● Please ensure smooth flow of water when installing the drain hose. 	

PRECAUTIONS DURING SHIFTING OR MAINTENANCE

 WARNING	<ul style="list-style-type: none"> ● Should abnormal situation arises (like burning smell), please stop operating the unit and turn off the circuit breaker. Contact your agent. Fault, short circuit or fire may occur if you continue to operate the unit under abnormal situation. 	 
	<ul style="list-style-type: none"> ● Please contact your agent for maintenance. Improper self maintenance may cause electric shock and fire. 	
	<ul style="list-style-type: none"> ● Please contact your agent if you need to remove and reinstall the unit. Electric shock or fire may occur if you remove and reinstall the unit yourself improperly. 	

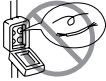
PRECAUTIONS DURING OPERATION

 WARNING	<ul style="list-style-type: none"> ● Avoid an extended period of direct air flow for your health. 	
	<ul style="list-style-type: none"> ● Do not put objects like thin rods into the panel of blower and suction side because the high-speed fan inside may cause danger. 	
	<ul style="list-style-type: none"> ● Do not use any conductor as fuse wire, this could cause fatal accident. 	
 	<ul style="list-style-type: none"> ● During thunder storm, disconnect and turn off the circuit breaker. 	

PRECAUTIONS DURING OPERATION

!
C
A
U
T
I
O
N

- The product shall be operated under the manufacturer specification and not for any other intended use.

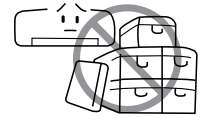

- Do not attempt to operate the unit with wet hands, this could cause fatal accident.

- When operating the unit with burning equipments, regularly ventilate the room to avoid oxygen insufficiency.

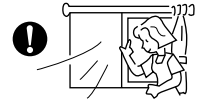

- Do not direct the cool air coming out from the air-conditioner panel to face household heating apparatus as this may affect the working of apparatus such as the electric kettle, oven etc.

- Please ensure that outdoor mounting frame is always stable, firm and without defect. If not, the outdoor unit may collapse and cause danger.



- Do not splash or direct water to the body of the unit when cleaning it as this may cause short circuit.

- Do not use any aerosol or hair sprays near the indoor unit. This chemical can adhere on heat exchanger fin and blocked the evaporation water flow to drain pan. The water will drop on tangential fan and cause water splashing out from indoor unit.

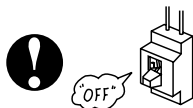

- Please switch off the unit and turn off the circuit breaker during cleaning, the high-speed fan inside the unit may cause danger.

- Turn off the circuit breaker if the unit is not to be operated for a long period.

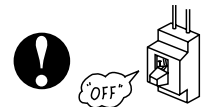

- Do not climb on the outdoor unit or put objects on it.

- Do not put water container (like vase) on the indoor unit to avoid water dripping into the unit. Dripping water will damage the insulator inside the unit and causes short-circuit.



- Do not place plants directly under the air flow as it is bad for the plants.

- When operating the unit with the door and windows opened, (the room humidity is always above 80%) and with the air deflector facing down or moving automatically for a long period of time, water will condense on the air deflector and drips down occasionally. This will wet your furniture. Therefore, do not operate under such condition for a long time.
- If the amount of heat in the room is above the cooling or heating capability of the unit (for example: more people entering the room, using heating equipments and etc.), the preset room temperature cannot be achieved.



NAMES AND FUNCTIONS OF EACH PART

INDOOR UNIT

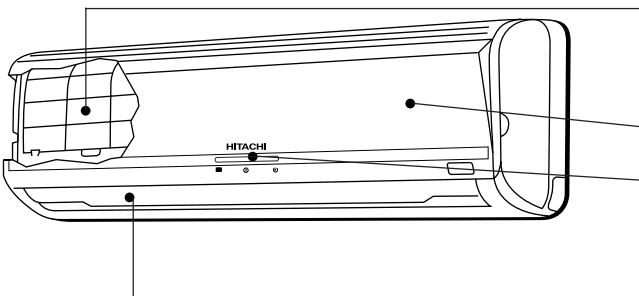

AIR FILTER

To prevent dust from coming into the indoor unit.
(Refer page 17)

FRONT PANEL (AIR INLET).

INDOOR UNIT INDICATORS

Light indicator showing the operating condition.
(Refer page 5)

HORIZONTAL DEFLECTOR • VERTICAL DEFLECTOR (AIR OUTLET)

(Refer page 12)

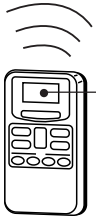

REMOTE CONTROL

Send out operation signal to the indoor unit. So as to operate the whole unit.
(Refer page 6)

OUTDOOR UNIT

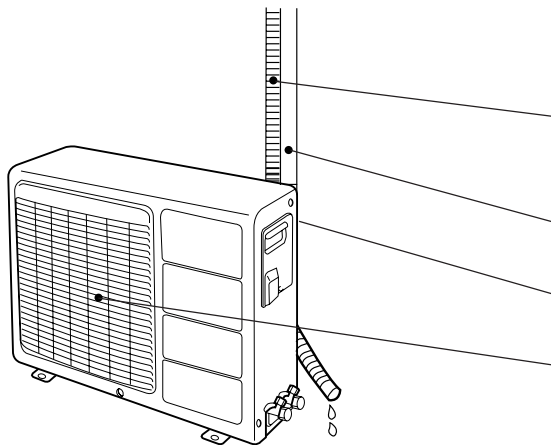

DRAIN PIPE

Condensed water drain to outside.

CONNECTING CORD

AIR INLET (BACK, LEFT SIDE)

AIR OUTLET

MODEL NAME AND DIMENSIONS

MODEL	WIDTH (mm)	HEIGHT (mm)	DEPTH (mm)
RAS-10C9 / 13C9	860	285	188
RAC-10C9 / 13C9	700	570	210

INDOOR UNIT INDICATORS

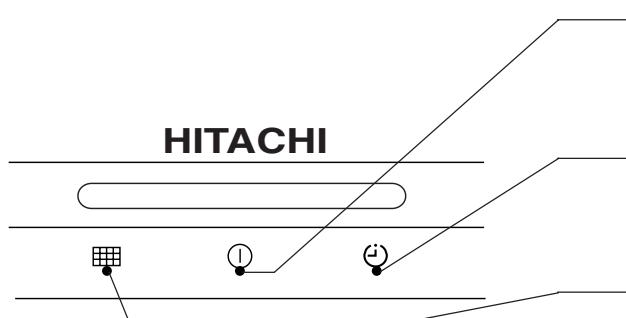

OPERATION LAMP

This lamp lights during operation.

TIMER LAMP

This lamp lights when the timer is working.

FILTER LAMP

When the device is operated for a total of about 200 hours, the FILTER lamp lights to indicate that it is time to clean the filter. The lamp goes out when the POWER SWITCH set to OFF and ON again.

OPERATION INDICATOR

- This figure shows the opening condition of front panel. Refer to page 20 in relation to how to open or close the front panel.

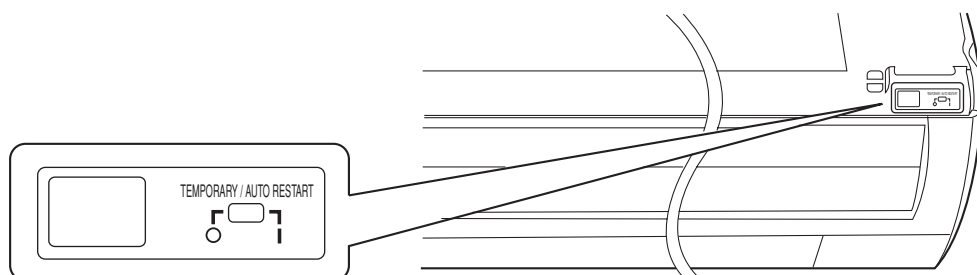

AUTO RESTART SWITCH

- In the event of power failure, the air conditioner will restart automatically in the previously selected mode once the power is restored.
- In the event of power failure during TIMER operation, the timer will be reset and the unit will begin or stop operating under a new timer setting.

TEMPORARY SWITCH

Use this switch to start and stop when the remote controller does not work.

- By setting the temporary switch, the operation is done in previously set operation mode.
- When the operation is done using the temporary switch after the power source is turned off and turn on again, the operation is done in automatic mode.

NAMES AND FUNCTIONS OF REMOTE CONTROL UNIT

■ This controls the operation function and timer setting of the room air conditioner. The range of control is about 4 meters. If indoor lighting is controlled electronically, the range of control may be shorter.

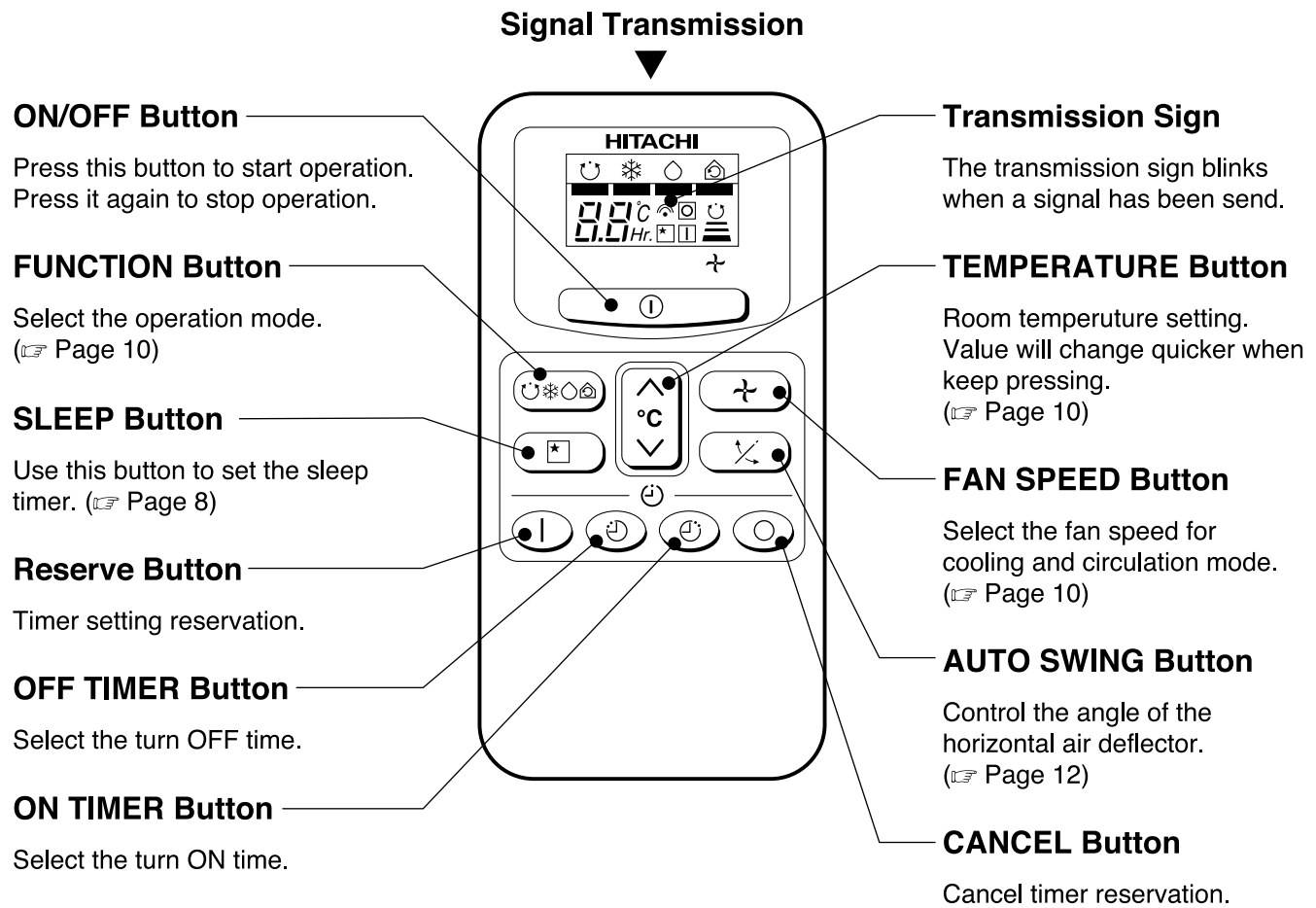

Precautions for Use

- Do not put the remote controller in direct sunlight and high temperature.
- Do not drop it on the floor, and protect it from water.
- If you press the FUNCTION selector button during operation, the air conditioner may stop for about 3 minutes for protection before you can start it again. (unless you turn off and on again the power source)

You can use the remote controller by fixing it on the wall with the accessory parts.

- Before fixing it, make sure the unit can be controlled by the remote control unit at the fixing position.

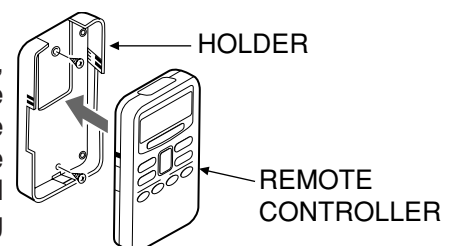

AUTOMATIC OPERATION

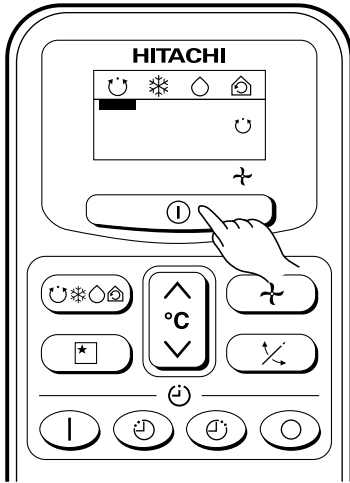

- The device will automatically determine the operation mode either COOL or DEHUMIDIFY, depending on the initial room temperature.



1 Press the  (START/STOP) button

- Operation start with a “beep”.

STOP Press the  (START/STOP) button

- Please make sure you have been selected the  (Automatic) mode by use the  (FUNCTION) Button.
- The fan speed selector does not work at this operation.

- You can slightly adjust the room temperature.

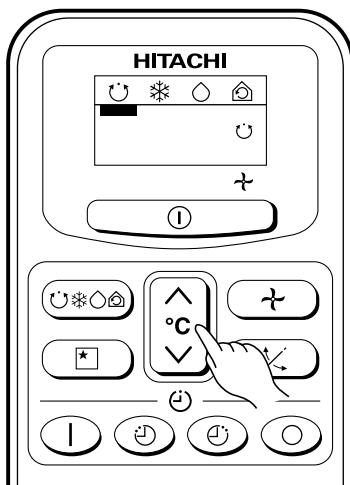

1 Press the  (ROOM TEMPERATURE) button

- Temperature setting change by 1°C for each 1 time press.



- You can raise or lower the temperature setting by a maximum of 3°C.
- The display does not indicate the preset temperature in the Automatic mode. Device will receive the setting by a “beep”.

CONDITION OF AUTOMATIC OPERATION

- The selected mode of operation will not change during the operation even though the room temperature change.

INITIAL ROOM TEMPERATURE (APPROX.)	FUNCTION	TEMPERATURE SETTING	FAN SPEED
Over 27°C →	COOL	27°C	HIGH at start, MEDIUM or LOW after the preset temperature is reached
16 ~ 27°C →	DEHUMIDIFY	Slightly lower than the room temperature	LOW

CIRCULATION OPERATION

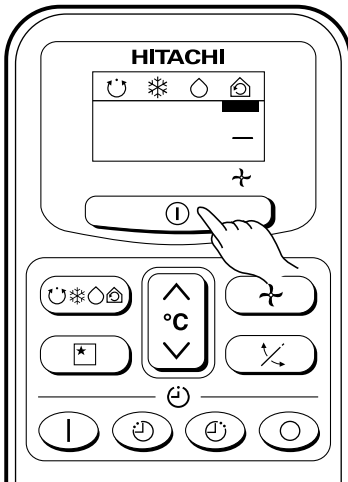

- When the room temperature is higher than the thermostat set temperature, only the fan operates to circulate the upper hotter air downwards. This makes temperature distribution of the room evenly at heating.



1 Press the (START/STOP) button

- Operation start with a signal received sound “beep”.

STOP Press the (START/STOP) button

- Make sure you have been select the  (Circulate) mode by using the  (FUNCTION) Button.
- You can select the fan speed and desired temperature.
- This operation is useful in winter when using other heating equipment.

HOW TO SET THE SLEEP TIMER

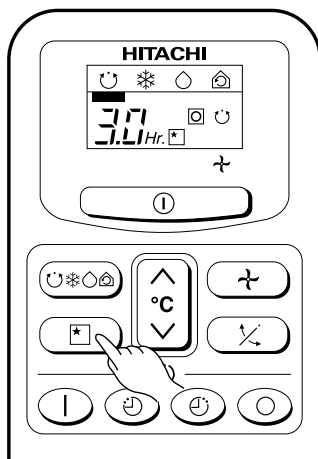

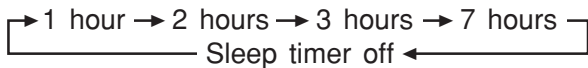

Mode	Indication
Sleep timer	

Sleep Timer: The device will continue working for the designated number of hours and then turn off. Point the signal window of the remote controller toward the indoor unit, and press the SLEEP button. The timer information will be displayed on the remote controller. The TIMER lamp lights with a beep from the indoor unit.

Example: Setting 3 hours sleep time.

How to Cancel Reservation

Point the signal window of the remote controller toward the indoor unit, and press the  (CANCEL) button.

The  (RESERVED) sign goes out with a beep and the  (TIMER) lamp turns off on the indoor unit.

NOTE

If you set the sleep timer when the off-timer or on/off-timer has been set earlier, the sleep timer becomes effective instead of the off- or on/off-timer set earlier.

Explanation of the sleep timer

The device will control the FAN SPEED and room temperature automatically so as to be quiet and good for people's health.

You can set the sleep timer to turn off after 1, 2, 3 or 7 hours. The FAN SPEED and room temperature will be controlled as shown below.

Operation with the sleep timer

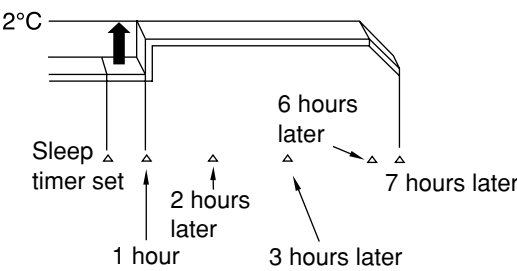
Function	Operation
Cooling “ ❄ ” and dehumidifying “ 💧 ”	The FAN SPEED will be set to LOW immediately. 
Fan “ + ”	The settings of room temperature and circulation are not varied.

MANUAL OPERATION [Cooling • Dehumidify • Circulation]

- Please use under below condition when you want to set the function mode, room temperature and fan speed by manually.

DEHUMIDIFYING	COOLING
Room Temperature 16°C above	Outdoor Temperature 22-42°C

1 OPERATION MODE SELECTION

- Every time you press the button, the mode will change as the below sequence

☺ (Auto) → ❄️ (Cool) → 💧 (Dehumidify) → 🏠 (Circulation)

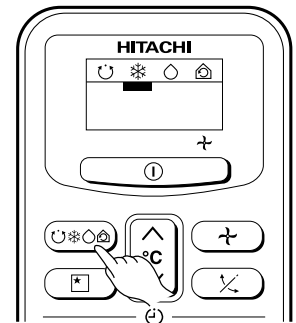

2 ROOM TEMPERATURE SETTING

		■ Recommend Temperature	
<div style="border: 1px solid black; padding: 2px; display: inline-block;"> ^ °C v </div>	◀ Up	Dehumidify	16~26°C
	◀ Down	Cooling	25~28°C

- The cooling operation does not start if the temperature setting is higher than the current room temperature.

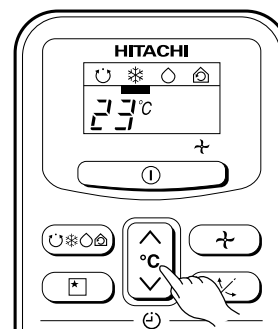

3 FAN SPEED SETTING

- Every time you press the button, fan speed will change as the below sequence.

- **COOLING** } : AUTO → HIGH → MED → LOW
- **CIRCULATION** } : (☺ → ≡ → = → -)

NOTE

☺ (Auto) : The FAN SPEED is HIGH at first and varies to MED or LOW automatically when the preset temperature has been reached.

- **DEHUMIDIFYING** : **LOW (FIXED)**
: (-)

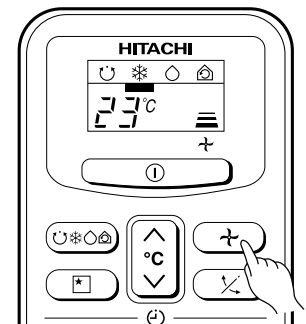

Dehumidify Function

When the room temperature is higher than the temperature setting: The device will dehumidify the room, reducing the room temperature to the preset level.

When the room temperature is lower than the temperature setting: Dehumidifying will be performed with the room temperature set slightly lower than the current room temperature, whatever the temperature setting. The function will stop (the indoor unit will stop emitting air) as soon as the room temperature becomes lower than the setting.

4 Press the (START/STOP) button

- Operation start with a signal received sound “beep”.

STOP Press the (START/STOP) button

- As the settings are stored in memory in the remote control unit, you only have to press the  (Start/Stop) button next time.

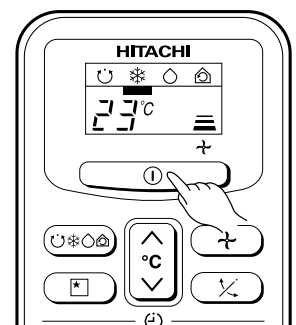

TIMER RESERVATION

■ ON Timer and OFF Timer are available.

OFF Timer Reservation

1 OFF TIME setting

- Select the OFF TIME by pressing the  (OFF) Button.
- Setting time will change according to the below sequence when you press the button.

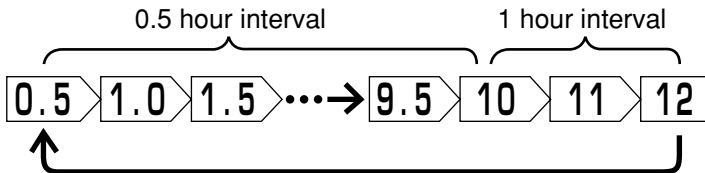

- The value change quicker if you keep pressing the button.

2 Press the (Reserve) button

- OFF TIMER reserved with a signal received sound "beep".
- The  (OFF) Mark starts lighting instead of blinking.

ON Timer Reservation

1 ON TIME setting

- Select the ON TIMER by pressing the  (ON) Button.
- At the beginning of setting, time 6 hours was set.
- Setting time will change according to the below sequence.

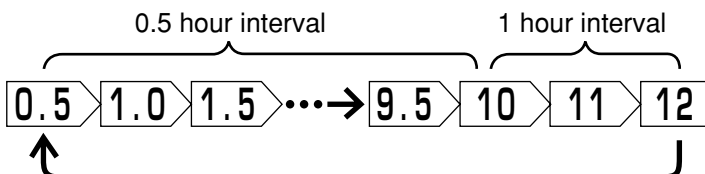

- The value change quicker if you keep pressing the button.

2 Press the (Reserve) button

- ON TIMER reserved with a signal received sound "beep".
- The  (ON) Mark starts lighting instead of blinking.

CANCELLATION of Timer Reservation

1 Press the (Cancel) button

- As the time settings are stored in remote controller memory, you only have to press the  (Reserve) button in order to use the same setting next time.

■ Operation stop at setting time

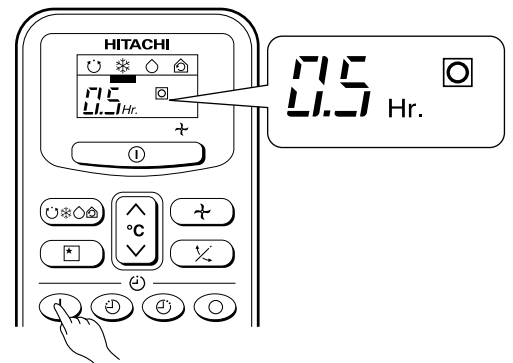
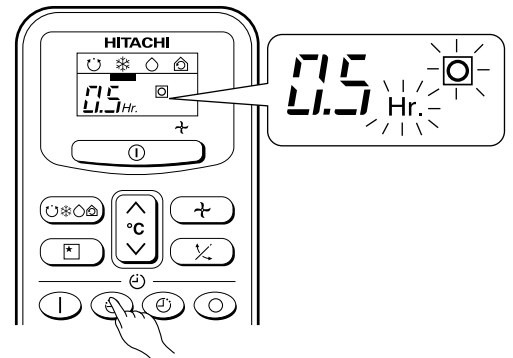

■ Operation will start for setting temperature at setting time (The starting time may different depend on the room temperature and set temperature).

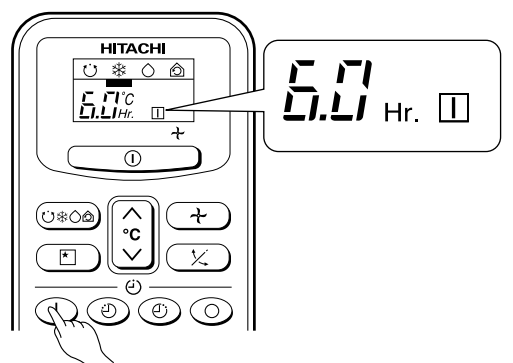
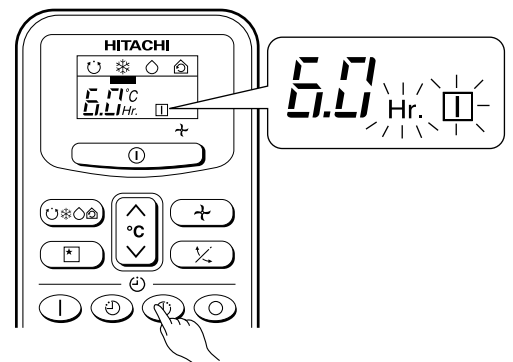

ADJUSTING THE AIR DEFLECTORS

1 Adjustment of the conditioned air in the upward and downward directions.

According to “Dehumidifying” or “Cooling” operation, the horizontal air deflector is automatically set to the proper angle suitable for each operation. The deflector can be swung up and down and also set to the desired angle using the “ (AUTO SWING)” button. (If the angle of the deflector is changed, it will not return to the auto-set position after operations start unless the operation mode is switched.)

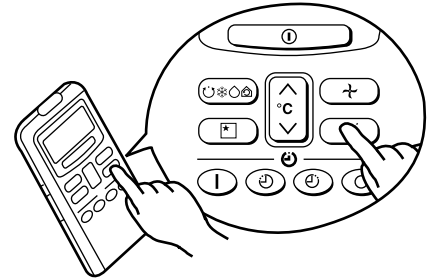

- If the “ (AUTO SWING)” button is pressed once, the horizontal air deflector swings up and down. If the button is pressed again, the deflector stops in its current position. Several seconds (about 6 seconds) may be required before the deflector starts to move.
- In “Cooling” operation, do not keep the horizontal air deflector swinging for a long time. Some dew may form on the horizontal air deflector and dew may drop.

2 Adjustment of the conditioned air to the left and right.

Hold the vertical air deflector as shown in the figure and adjust the conditioned air to the left and right.

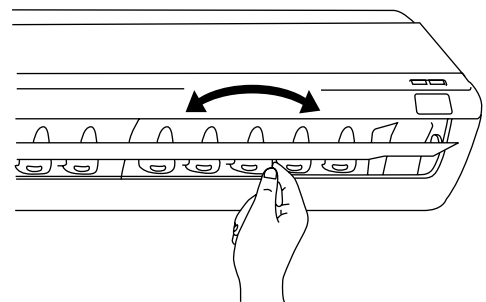

HOW TO EXCHANGE THE BATTERIES IN THE REMOTE CONTROLLER

1 Remove the cover as shown in the figure and take out the old batteries.



2 Install the new batteries.
The direction of the batteries should match the marks in the case.

CAUTION

1. Do not use new and old batteries, or different kinds of batteries together.
2. Take out the batteries when you do not use the remote controller for 2 or 3 months.

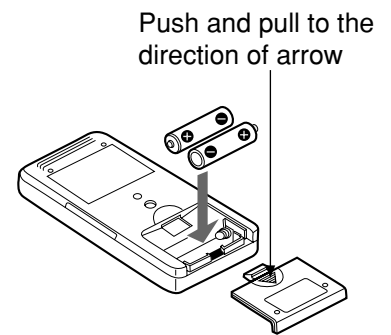

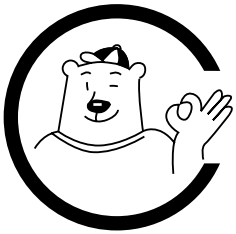

THE IDEAL WAYS OF OPERATION

Suitable Room Temperature

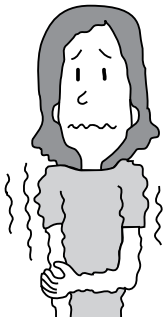

⚠ Warning
Freezing temperature is bad for health and a waste of electric power.

Install curtain or blinds

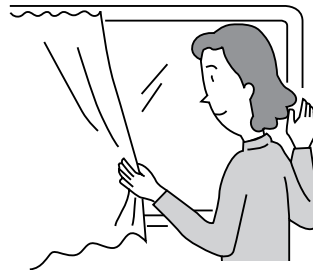

It is possible to reduce heat entering the room through windows.

Ventilation

⚠ Caution
Do not close the room for a long period of time. Occasionally open the door and windows to allow the entrance of fresh air.



Effective Usage Of Timer

At night, please use the “sleep timer operation mode”, together with your wake up time in the morning. This will enable you to enjoy a comfortable room temperature. Please use the timer effectively.

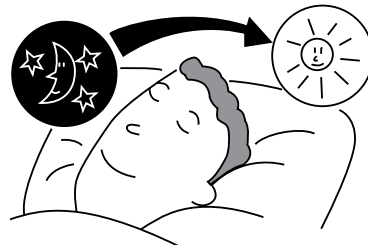

Do Not Forget To Clean The Air Filter

Dusty air filter will reduce the air volume and the cooling efficiency. To prevent from wasting electric energy, please clean the filter every 2 weeks.

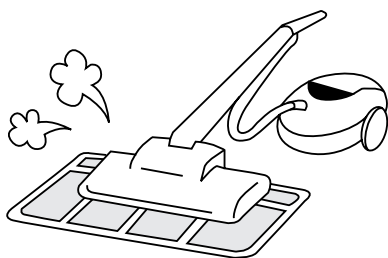

Please Adjust Suitable Temperature For Baby And Children

Please pay attention to the room temperature and air flow direction when operating the unit for baby, children and old folks who have difficulty in movement. (The ideal temperature difference between outdoor and indoor is about $\pm 5^{\circ}\text{C}$).

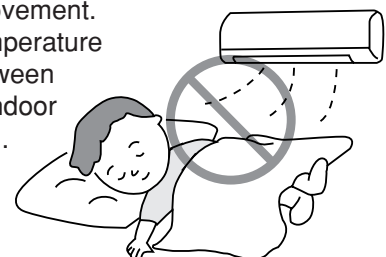



FOR USER'S INFORMATION

The Air Conditioner And The Heat Source In The Room

⚠ Caution

If the amount of heat in the room is above the cooling capability of the air conditioner (for example: more people entering the room, using heating equipments and etc.), the preset room temperature cannot be achieved.

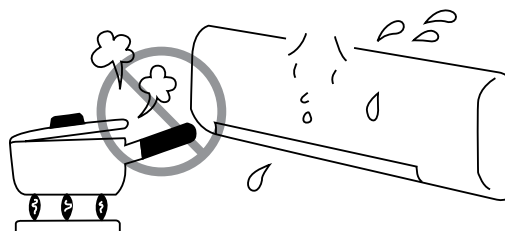

Not Operating For A Long Time

When the indoor unit is not to be used for a long period of time, please switch off the power from the mains. If the power from mains remains "ON", the indoor unit still consumes about 8W in the operation control circuit even if it is in "OFF" mode.

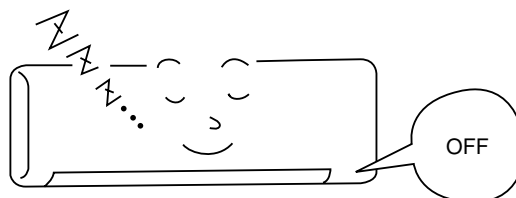

When Lightning Occurs

⚠ Warning

To protect the whole unit during lightning, please stop operating the unit and remove the plug from the socket.

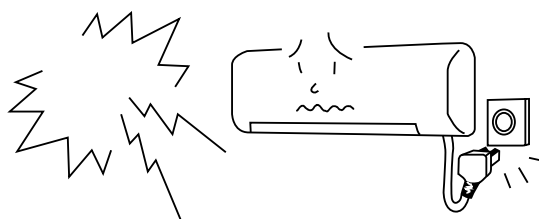

Interference From Electrical Products

⚠ Caution

To avoid noise interference, please place the indoor unit and its remote controller at least 1m away from electrical products.

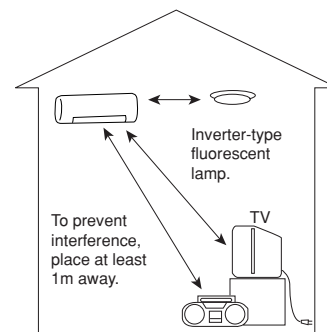

ATTACHING THE AIR CLEANSING AND DEODORIZING FILTERS

CAUTION

Cleaning and maintenance must be carried out only by qualified service personal. Before cleaning, stop operation and switch off the power supply.

1 Open the front panel.

- Pull up the front panel by holding it at both sides with both hands.

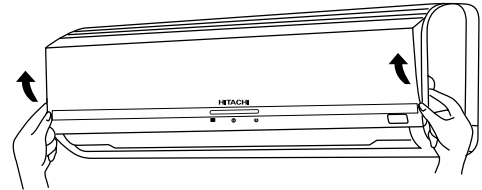

2 Remove the filter.

- Push upward to release the claws and pull out the filter.

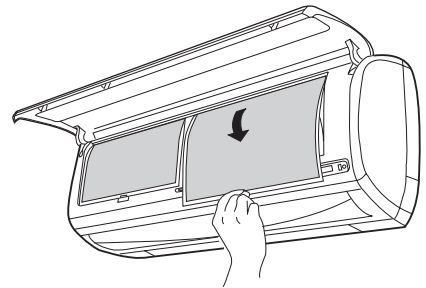

3 Attaching the Nano Titanium filters to the filter.

- Attach the Nano Titanium filters to the frame by gently compress its both sides and release after insertion into filter frame.

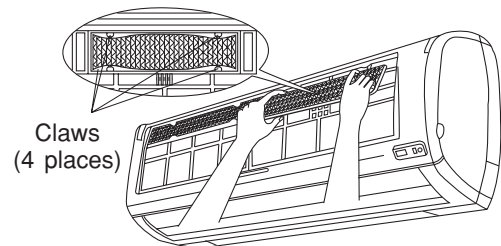

CAUTION

Do not bend the Nano Titanium filter as it may cause damage to the structure.

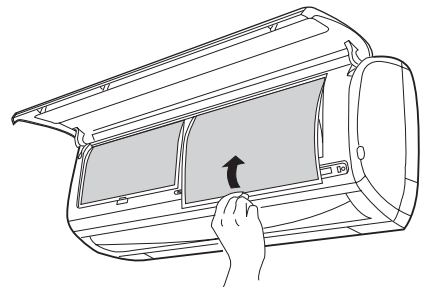

4 Attach the filters.

- Attach the filters by ensuring that the surface written "FRONT" is facing front.
- After attaching the filters, push the front panel at three arrow portion as shown in figure and close it.

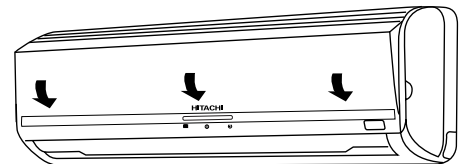

NOTE

- In case of removing the Nano Titanium filters, please follow the above procedures.
- The cooling capacity is slightly weakened and the cooling speed becomes slower when the Nano Titanium filters are used. So, set the fan speed to "HIGH" when using it in this condition.
- Nano Titanium filters are not washable and can be use in 1 year time. Type number for this air cleansing filter is <SPX-CFH14>. Please use this number for ordering when you want it.
- Nano Titanium filter only be provided in standard models only. For the strategic models it is an optional.
- Do not operate the air conditioner without filter. Dust may enter the air conditioner and fault may occur.

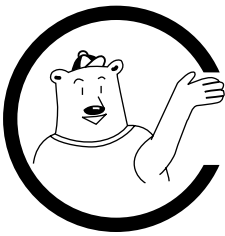

MAINTENANCE

⚠ CAUTION

Cleaning and maintenance must be carried out only by qualified service personal. Before cleaning, stop operation and switch off the power supply.

1. AIR FILTER

Clean the air filter, as it removes dust inside the room. In case the air filter is full of dust, the air flow will decrease and the cooling capacity will be reduced. Further, noise may occur. Be sure to clean the filter following the procedure below.

PROCEDURE

- 1 Open the front panel and remove the filter
 - Gently lift and remove the air cleansing and deodorizing filter from the air filter frame.

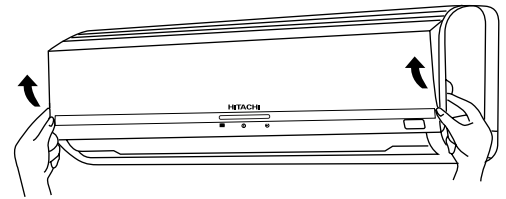

- 2 Vacuum dust from the air filter and Nano Titanium filter using vacuum cleaner. If there is too much dust, air filter only rinse under running tap water and gently brush it with soft bristle brush. Allow filters to dry in shade.

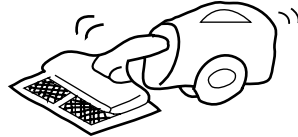
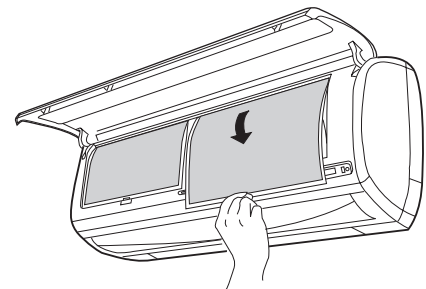

- 3
 - Re-insert the air cleansing and deodorizing filter to the filter frame. Set the filter with "FRONT" mark facing front, and slot them into the original state.
 - After attaching the filters, push the front panel at three arrow portions as shown in figure and close it.

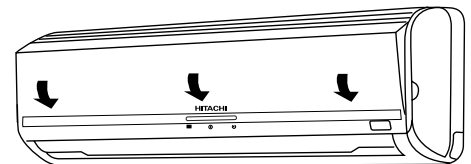

NOTE:

- Nano Titanium filter should be cleaned every month or sooner if noticeable loading occurs. When used overtime, it may loose its deodorizing function. For maximum performance, it is recommended to replace it every 1 year depending on application requirements.

⚠ CAUTION

- Do not wash with hot water at more than 40°C. The filter may shrink.
- When washing it, shake off moisture completely and dry it in the shade; do not expose it directly to the sun. The filter may shrink.
- Do not use detergent on the air cleansing and deodorizing filter as some detergent may deteriorate the filter electrostatic performance.

2. CLEANING OF FRONT PANEL

- Wipe it with a soft dry cloth.
- When it is excessively dirty, wipe with a soft cloth soaked in lukewarm water or neutral detergent. Then wipe thoroughly with a soft dry cloth.
- Wipe the remote controller thoroughly with a soft dry cloth.



Removing the Front Panel

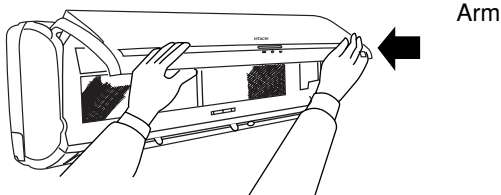

- When the front panel is fully opened with both hands, push the right arm to the inside to release it, and while closing the front panel slightly, pull it out forward.

Attaching the Front Panel

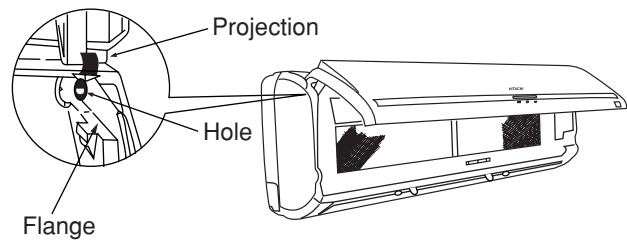

- Move the projections of the left and right arms into the **Flanges** in the unit and securely insert them into the holes.

CAUTION

- Never use hot water (above 40°C), benzene, gasoline, acid, thinner or a brush, because they will damage the plastic surface and the coating.

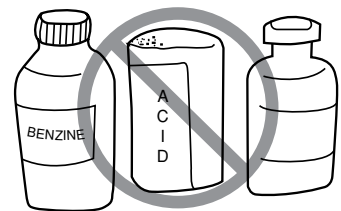

3. MAINTENANCE AT BEGINNING OF LONG OFF PERIOD

- Running the unit setting the operation mode to  (FAN) and the fan speed to HI for about half a day on a fine day, and dry the whole of the unit.
- Disconnect the power plug.

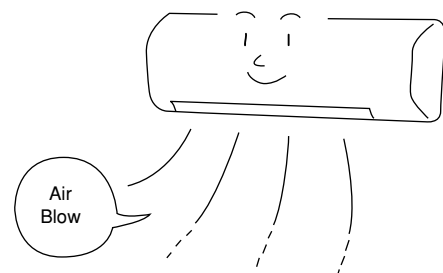

⚠ CAUTION

- Please use earth line.
Do not place the earth line near water or gas pipes, lightning-conductor, or the earth line of telephone. Improper installation of earth line may cause electric shock.
- A circuit breaker should be installed depending on the mounting site of the unit. Without a circuit breaker, the danger of electric shock exists.

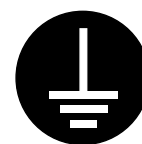

IMPORTANT

The wires in this mains lead are coloured in accordance with the following code:

- Green-and-yellow : Earth
- Blue : Neutral
- Brown : Live

As the colours of the wires in the mains lead of this appliance may not correspond with the coloured markings identifying the terminals in your plug, proceed as follows:

The wire which is coloured green-and-yellow must be connected to the terminal in the plug which is marked with the letter E or by the earth symbol (⏏) or coloured green or green-and-yellow.

The wire which is coloured blue must be connected to the terminal which is marked with the letter N or coloured black.

The wire which is coloured brown must be connected to the terminal which is marked with the letter L or coloured red.

NOTE

If the supply cord is damaged, it must be replaced by the special cord obtainable at authorized service/parts centers.

⚠ CAUTION

Cleaning and maintenance must be carried out only by qualified service personal. Before cleaning, stop operation and switch off the power supply.

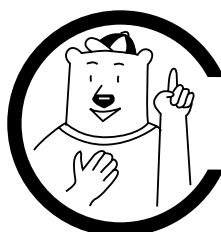

REGULAR INSPECTION

PLEASE CHECK THE FOLLOWING POINTS EITHER EVERY HALF YEARLY OR YEARLY. CONTACT YOUR SALES AGENT SHOULD YOU NEED ANY HELP.

1		<p>Is the plug of power line firmly plugged into the socket? (Please ensure no loose contact between them).</p>
2		<p>Is the earth line disconnected or broken?</p>
3		<p>Is the mounting frame seriously affected by rust and is the outdoor unit tilted or unstable?</p>



AFTER SALE SERVICE AND WARRANTY

WHEN ASKING FOR SERVICE, CHECK THE FOLLOWING POINTS.

CONDITION	CHECK THE FOLLOWING POINTS
<p>When it does not operate</p>	<ul style="list-style-type: none"> ● Is the fuse all right? ● Is the voltage extremely high or low? ● Is the circuit breaker "ON"?
<p>When it does not cool well</p>	<ul style="list-style-type: none"> ● Is the air filter blocked with dust? ● Does sunlight fall directly on the outdoor unit? ● Is the air flow of the outdoor unit obstructed? ● Are the doors or windows opened, or is there any source of heat in the room? ● Is the set temperature suitable?



Notes

- In quiet operation or stopping the operation, the following phenomena may occasionally occur, but they are not abnormal for the operation.
 - (1) Slight flowing noise of refrigerant in the refrigerating cycle.
 - (2) Slight rubbing noise from the fan casing which is cooled and then gradually warmed as operation stops.
- The odor will possibly be emitted from the room air conditioner because the various odor, emitted by smoke, foodstuffs, cosmetics and so on, sticks to it. So please clean the air filter and the evaporator regularly to reduce the odor.

- Please contact your sales agent immediately if the air conditioner still fails to operate normally after the above inspections. Inform your agent of the model of your unit, production number, date of installation. Please also inform him regarding the fault.
- Power supply shall be connected at the rated voltage, otherwise the unit will be broken or could not reach the specified capacity.

NOTE:

If the supply cord is damaged, it must be replaced by the special cord obtainable at authorized service parts centers.

