

# HITACHI

Inspire the Next

*SPLIT TYPE*

## INDOOR UNIT/OUTDOOR UNIT

### MODEL

**RAS-18CX9KS/RAC-18CX9**

**RAS-24CX9KS/RAC-24CX9**

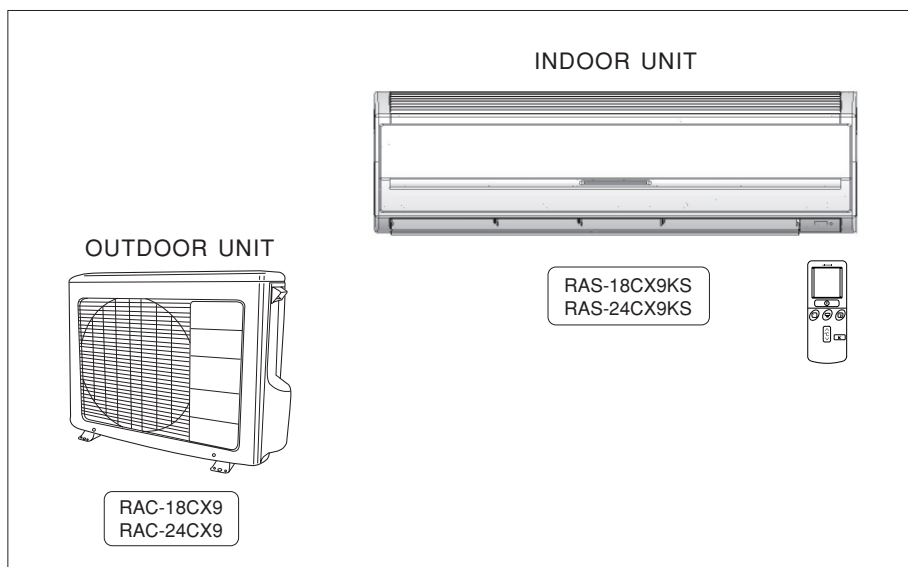

### Instruction manual

To obtain the best performance and ensure years of trouble free use, please read this instruction manual completely.

Page 1~28

### 使用說明書



請詳細閱讀這本使用說明書以了解正確的使用法，使機器長久發揮最高性能。

29~58頁







# SAFETY PRECAUTION

- Please read the “Safety Precaution” carefully before operating the unit to ensure correct usage of the unit.
- Pay special attention to signs of “**▲ Warning**” and “**▲ Caution**”. The “Warning” section contains matters which, if not observed strictly, may cause death or serious injury. The “Caution” section contains matters which may result in serious consequences if not observed properly. Please observe all instructions strictly to ensure safety.
- The sign indicate the following meanings.



 Make sure to connect earth line.	 The sign in the figure indicates prohibition.
 Indicates the instructions that must be followed.	

- Please keep this manual after reading.





## PRECAUTIONS DURING INSTALLATION

 <b>WARNING</b>	<ul style="list-style-type: none"> <li>● Do not reconstruct the unit. Water leakage, fault, short circuit or fire may occur if you reconstruct the unit by yourself.</li> </ul>	
	<ul style="list-style-type: none"> <li>● Please ask your sales agent or qualified technician for the installation of your unit. Water leakage, short circuit or fire may occur if you install the unit by yourself.</li> </ul>	
 <b>CAUTION</b>	<ul style="list-style-type: none"> <li>● Please use earth line. Do not place the earth line near water or gas pipes, lightning-conductor, or the earth line of telephone. Improper installation of earth line may cause electric shock.</li> </ul>	
	<ul style="list-style-type: none"> <li>● A circuit breaker should be installed depending on the mounting site of the unit. Without a circuit breaker, the danger of electric shock exists.</li> <li>● Do not install near location where there is flammable gas. The outdoor unit may catch fire if flammable gas leaks around it.</li> <li>● Please ensure smooth flow of water when installing the drain hose.</li> </ul>	

## PRECAUTIONS DURING SHIFTING OR MAINTENANCE

 <b>WARNING</b>	<ul style="list-style-type: none"> <li>● Should abnormal situation arises (like burning smell), please stop operating the unit and turn off the circuit breaker. Contact your agent. Fault, short circuit or fire may occur if you continue to operate the unit under abnormal situation.</li> </ul>	
	<ul style="list-style-type: none"> <li>● Please contact your agent for maintenance. Improper self maintenance may cause electric shock and fire.</li> </ul>	
	<ul style="list-style-type: none"> <li>● Please contact your agent if you need to remove and reinstall the unit. Electric shock or fire may occur if you remove and reinstall the unit yourself improperly.</li> </ul>	

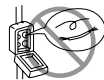
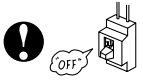
## PRECAUTIONS DURING OPERATION

 <b>WARNING</b>	<ul style="list-style-type: none"> <li>● Avoid an extended period of direct air flow for your health.</li> </ul>	
	<ul style="list-style-type: none"> <li>● Do not insert a finger, a rod or other objects into the air outlet or inlet. As the fan is rotating at a high speed, it will cause injury. Before cleaning, be sure to stop the operation and turn the breaker OFF.</li> </ul>	
	<ul style="list-style-type: none"> <li>● Do not use any conductor as fuse wire, this could cause fatal accident.</li> </ul>	
	<ul style="list-style-type: none"> <li>● During thunder storm, disconnect and turn off the circuit breaker.</li> </ul>	
	<ul style="list-style-type: none"> <li>● This unit has UV LED which emits ultra violet light. AVOID DIRECT EYE EXPOSURE.</li> </ul>	

## PRECAUTIONS DURING OPERATION

- The product shall be operated under the manufacturer specification and not for any other intended use.

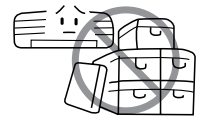

- Do not attempt to operate the unit with wet hands, this could cause fatal accident.

- When operating the unit with burning equipments, regularly ventilate the room to avoid oxygen insufficiency.

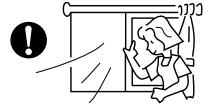

- Do not direct the cool air coming out from the air-conditioner panel to face household heating apparatus as this may affect the working of apparatus such as the electric kettle, oven etc.

- Please ensure that outdoor mounting frame is always stable, firm and without defect. If not, the outdoor unit may collapse and cause danger.

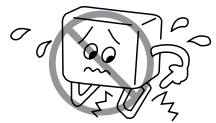

- Do not splash or direct water to the body of the unit when cleaning it as this may cause short circuit.

- Do not use any aerosol or hair sprays near the indoor unit. This chemical can adhere on heat exchanger fin and blocked the evaporation water flow to drain pan. The water will drop on tangential fan and cause water splashing out from indoor unit.



**CAUTION**

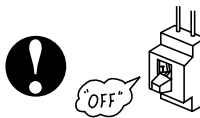

- Please switch off the unit and turn off the circuit breaker during cleaning, the high-speed fan inside the unit may cause danger.

- Turn off the circuit breaker if the unit is not to be operated for a long period.

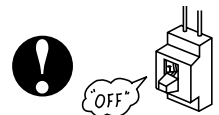

- Do not climb on the outdoor unit or put objects on it.

- Do not put water container (like vase) on the indoor unit to avoid water dripping into the unit. Dripping water will damage the insulator inside the unit and causes short-circuit.

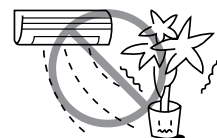

- Do not place plants directly under the air flow as it is bad for the plants.

- When operating the unit with the door and windows opened, (the room humidity is always above 80%) and with the air deflector facing down or moving automatically for a long period of time, water will condense on the air deflector and drips down occasionally. This will wet your furniture. Therefore, do not operate under such condition for a long time.

- If the amount of heat in the room is above the cooling or heating capability of the unit (for example: more people entering the room, using heating equipments and etc.), the preset room temperature cannot be achieved.

- This appliance is not intended for use by young children or infirm persons unless they have been adequately supervised by a responsible person to ensure that they can use the appliance safely.
- Young children should be supervised to ensure that they do not play with the appliance.

# NAMES AND FUNCTIONS OF EACH PART

## INDOOR UNIT

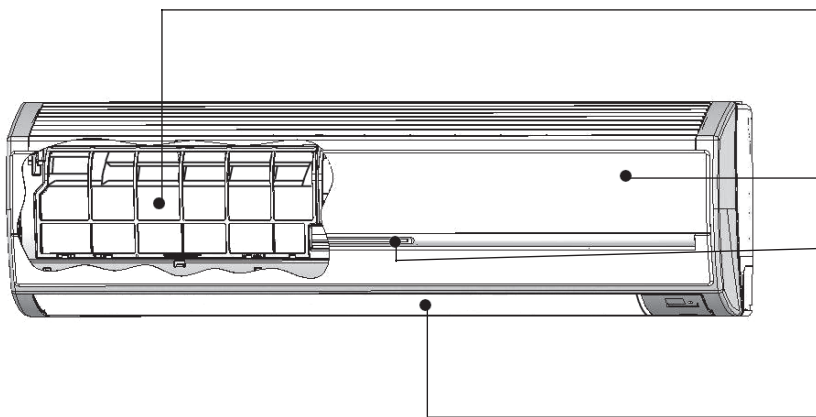

### AIR FILTER

To prevent dust from coming into the indoor unit.  
(Refer page 23)

### FRONT PANEL (AIR INLET).

### INDOOR UNIT INDICATORS

Light indicator showing the operating condition.  
(Refer page 5)

### HORIZONTAL DEFLECTOR ● VERTICAL DEFLECTOR (AIR OUTLET)

(Refer page 18)

### REMOTE CONTROLLER

Send out operation signal to the indoor unit. So as to operate the whole unit.  
(Refer page 6)

## OUTDOOR UNIT

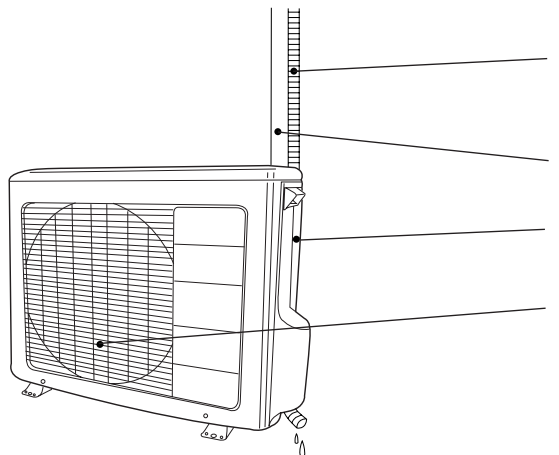

### Drain pipe

Condensed water drain to outside.

### Connecting cord and insulation pipe for piping

### Air inlet (Back and Left side)

### Air outlet

## MODEL NAME AND DIMENSIONS

MODEL	WIDTH (mm)	HEIGHT (mm)	DEPTH (mm)
RAS-18CX9KS, RAS-24CX9KS	1150	333	245
RAC-18CX9, RAC-24CX9	850	650	298

## OPERATION INDICATOR

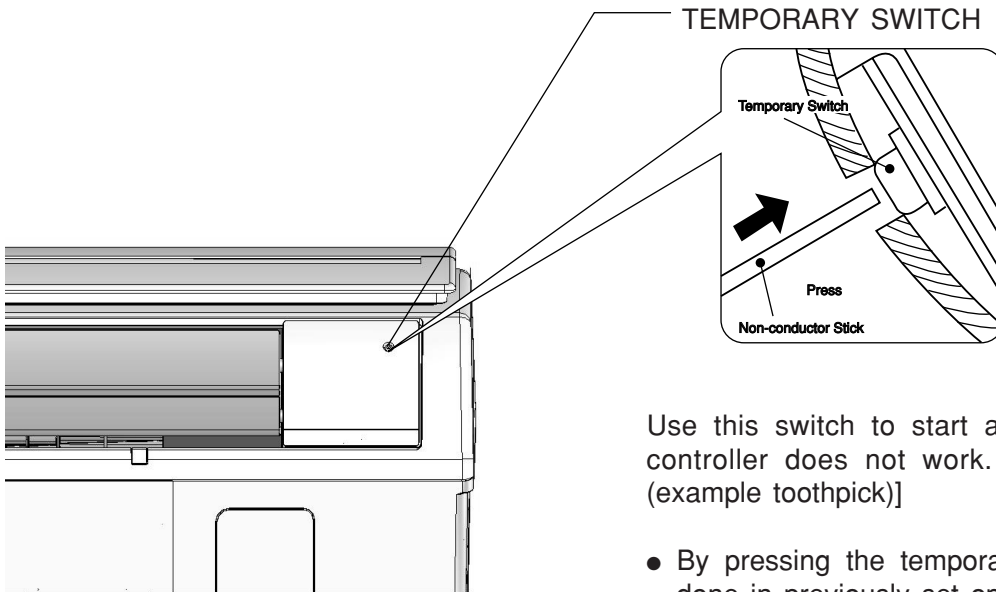

Use this switch to start and stop when the remote controller does not work. [Use non-conductor stick (example toothpick)]

- By pressing the temporary switch, the operation is done in previously set operation mode.
- When the operation is done using the temporary switch after the power source is turned off and turn on again, the operation is done in automatic mode.

## INDOOR UNIT INDICATORS

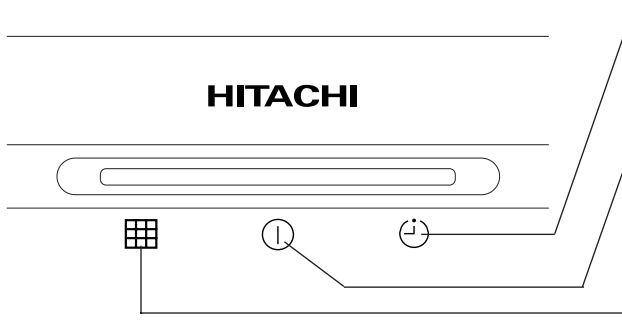

### TIMER LAMP

This lamp lights when the timer is working.

### OPERATION LAMP

This lamp lights during operation.

### FILTER LAMP

When the device is operated for a total of about 200 hours, the FILTER lamp lights to indicate that it is time to clean the filter. The lamp goes out when the "  (AUTO SWING)" button is pressed while the device is on "STANDBY MODE".

# NAMES AND FUNCTIONS OF EACH PART

## REMOTE CONTROLLER

This controls the operation of the indoor unit. The range of control is about 7 meters. If indoor lighting is controlled electronically, the range of control may be shorter.

This unit can be fixed on a wall using the fixture provided. Before fixing it, make sure the indoor unit can be controlled from the remote controller.

**Signal Transmission**

**Transmission sign**  
The transmission sign blinks when a signal is sent.

**Display**  
This indicates the room temperature selected, current time, timer status, function and intensity of circulation selected.

**START/STOP button**  
Press this button to start operation. Press it again to stop operation.

**SLEEP button**  
Use this button to set the sleep timer.

**SUPER SILENT button**  
Use this button to set silent condition.

**SUPER COOLING button**  
Use this button to set super cooling operation.

**AUTO SWING button**  
Controls the angle of the horizontal air deflector.

**TEMPERATURE button**  
Use this button to raise or lower the temperature setting. (Keep pressed, and the value will change more quickly.)

**OFF-TIMER button** Select the turn OFF time.

**ON-TIMER button** Select the turn ON time.

**TIME button**  
Use this button to set and check the time and date.

**RESET button**

**FUNCTION selector**  
Use this button to select the operating mode. Every time you press it, the mode will change from (AUTO) to (COOL) to (DEHUMIDIFY) to (CIRCULATION) and to (FAN) cyclically.

**FAN SPEED selector**  
This determines the fan speed. Every time you press this button, the intensity of circulation will change from (AUTO) to (HI) to (MED) to (LOW) (during the (FAN) mode, from HI to MED to LOW).

**PARALLEL SWING button**  
Controls the angle of the vertical air deflectors to parallel.

**SYMMETRY SWING button**  
Controls the angle of the vertical air deflectors to symmetry.

**TIMER control**  
Use this button to set the timer.

**RESERVE button** Time setting reservation.

**CANCEL button** Cancel time reservation.

	AUTO
	COOL
	DEHUMIDIFY
	AIR CIRCULATION
	FAN
	FAN SPEED
	HI
	MED
	LOW
	SUPER COOLING
	SUPER SILENT
	SLEEPING
	STOP (CANCEL)
	START (RESERVE)
	START/STOP
	TIME
	TIMER SET
	TIMER SELECTOR
	ON TIMER
	OFF TIMER
	AUTO SWING
	PARALLEL SWING
	SYMMETRY SWING

**Precautions for Use**

- Do not put the remote controller in the following places.
  - In direct sunlight.
  - In the vicinity of a heater.
- Handle the remote controller carefully. Do not drop it on the floor, and protect it from water.
- Once the outdoor unit stops, it will not restart for about 3 minutes (unless you turn the power switch off and on or unplug the power cord and plug it in again).  
This is to protect the device and does not indicate a failure.
- If you press the FUNCTION selector button during operation, the device may stop for about 3 minutes for protection.

# AUTOMATIC OPERATION

The device will automatically determine the mode of operation, COOL or DEHUMIDIFY depending on the initial room temperature. The selected mode of operation will not change when the room temperature varies.

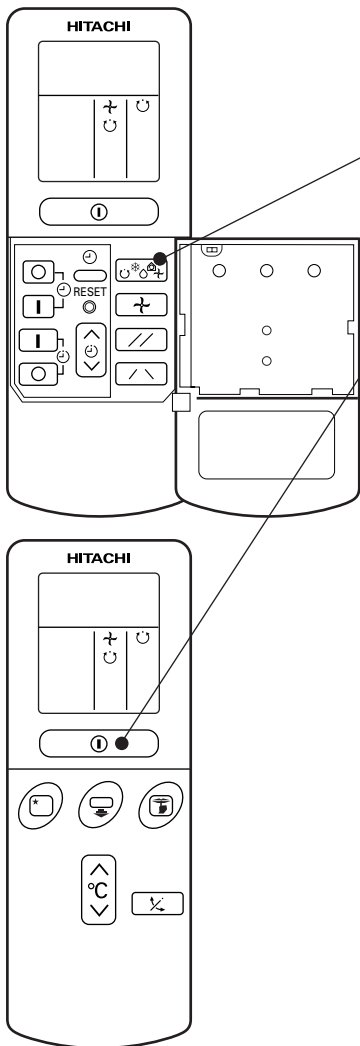

**1**

Press the FUNCTION selector so that the display indicates the (AUTO) mode of operation.

- When AUTO has been selected, the device will automatically determine the mode of operation COOL or Dehumidify, depending on the initial room temperature and outdoor temperature.

**START STOP**

Press the (START/STOP) button.  
 Operation starts with a beep.  
 Press the button again to stop operation.

■ As the settings are stored in memory in the remote controller, you only have to press the (START/STOP) button next time.

You can raise or lower the temperature setting as necessary by maximum of 3°C.

Press the temperature button and the temperature setting will change by 1°C each time.

- The preset temperature and the actual room temperature may vary somewhat depending on conditions.
- The display does not indicate the preset temperature in the AUTO mode. If you change the setting, the indoor unit will produce a beep.

## ■ CONDITION OF AUTOMATIC OPERATION

- The selected mode of operation will not change during the operation even though the room temperature change.

INITIAL ROOM TEMPERATURE (APPROX.)	FUNCTION	TEMPERATURE SETTING	FAN SPEED
Over 27°C	➔ COOL	27°C	HIGH at start, LOW after the preset temperature is reached.
16~27°C	➔ DEHUMIDIFY	Slightly lower than the room temperature	LOW

# COOLING OPERATION

Use the device for cooling when the outdoor temperature is 21-43°C.\*  
 If humidity is very high (over 80%) indoors, some dew may form on the air outlet grille of the indoor unit.

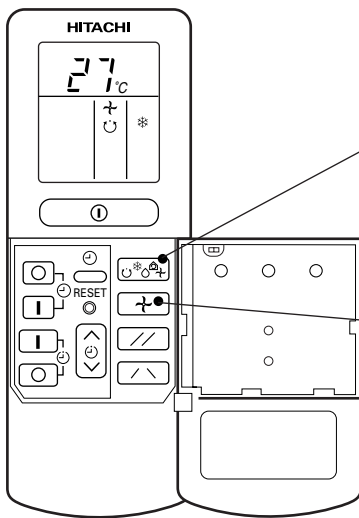

**1** Press the FUNCTION selector so that the display indicates ❄️ (COOL).

Set the desired FAN SPEED with the (FAN SPEED) button (the display indicates the setting).

(AUTO): The FAN SPEED is HI at first and varies to MED or LOW automatically when the preset temperature has been reached.

(HI) : Economical as the room will become cool quickly.

(MED) : Quiet.

(LOW) : More quiet.

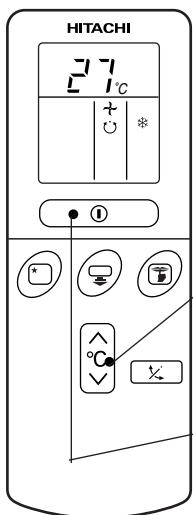

Set the desired room temperature with the TEMPERATURE buttons (the display indicates the setting).



The range of 25-28°C is recommended as the room temperature for cooling.

If the temperature setting is 27°C, the room temperature will be controlled at around 27°C.

The temperature setting and the actual room temperature may vary somewhat depending on conditions.

**START  
STOP**

Press the (START/STOP) button. Cooling operation starts with a beep. Press the button again to stop operation. The cooling function does not start if the temperature setting is higher than the current room temperature (even though the (OPERATION) lamp lights). The cooling function will start as soon as you set the temperature below the current room temperature.

■ As the settings are stored in memory in the remote controller, you only have to press the (START/STOP) button next time.

# DEHUMIDIFYING OPERATION

Use the device for dehumidifying when the room temperature is over 16°C.  
When it is under 15°C, the dehumidifying function will not work.

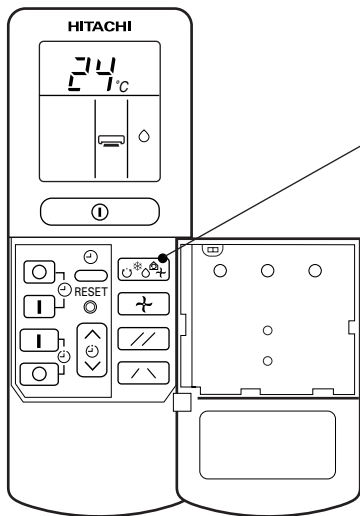

1

Press the FUNCTION selector so that the display indicates ◯ (DEHUMIDIFY).  
The FAN SPEED is set at LOW automatically.  
The FAN SPEED button does not work.

2

Set the desired room temperature with the TEMPERATURE button (the display indicates the setting).

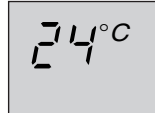

The range of 20-26°C is recommended as the room temperature for dehumidifying.

START  
STOP

Press the Ⓜ (START/STOP) button. Dehumidifying operation starts with a beep. Press the button again to stop operation.

- As the settings are stored in memory in the remote controller, you only have to press the Ⓜ (START/STOP) button next time.

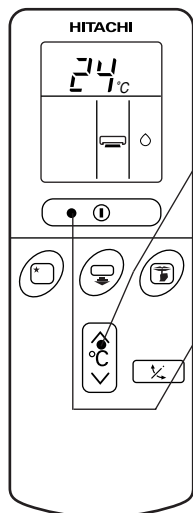

## ■ Dehumidifying Function

When the room temperature is higher than the temperature setting: The device will dehumidify the room, reducing the room temperature to the preset level.

When the room temperature is lower than the temperature setting: Dehumidifying will be performed at the temperature setting slightly lower than the current room temperature, regardless of the temperature setting. The function will stop (the indoor unit will stop emitting air) as soon as the room temperature becomes lower than the setting temperature.

# FAN OPERATION

You can use the device simply as an air circulator. Use this function to dry the interior of the indoor unit at the end of summer.

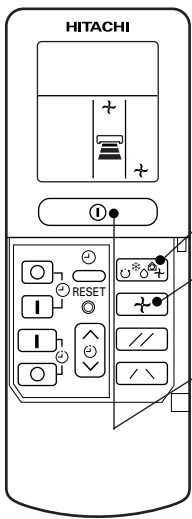

**1**

Press the FUNCTION selector so that the display indicates  (FAN).

**2**

Press the  (FAN SPEED) button.

**START  
STOP**

Press the  (START/STOP) button. Fan operation starts with a beep. Press the button again to stop operation.

# CIRCULATION OPERATION

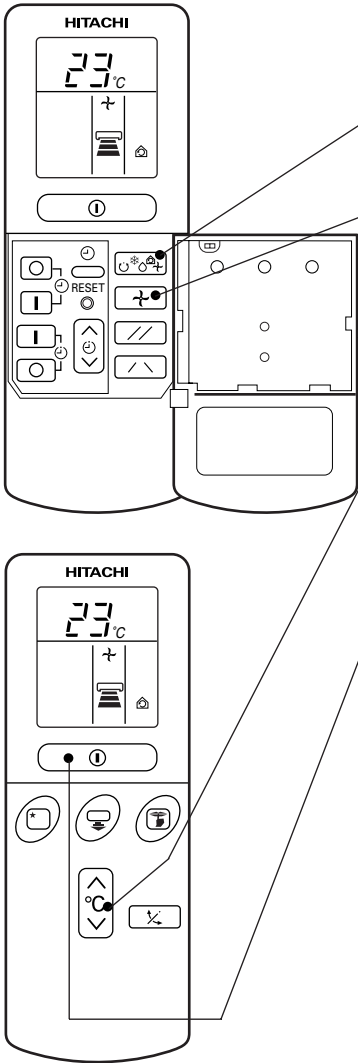

**1**

Press the FUNCTION selector so that the display indicates  (CIRCULATE).

**2**

Press the FAN SPEED button and select the desired FAN SPEED (the display indicates your choice).

**3**

Press the temperature control button to set to the desired temperature.

**START  
STOP**

Press the  (START/STOP) button. Circulating operation starts with a beep. Press the button again to stop operation.



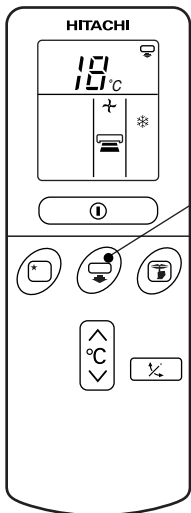

■ As the settings are stored in memory in the remote controller, you only have to press the  (START/STOP) button next time.

# SUPER COOLING







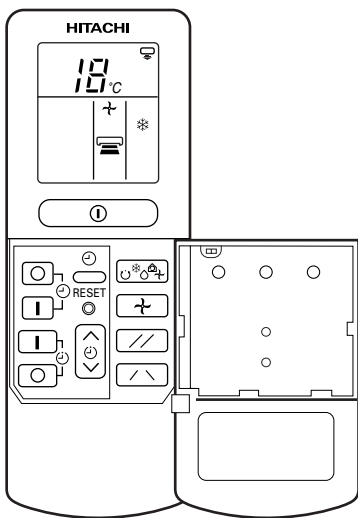

1

Press the  button.



- Operation start with a signal received sound “beep”.
- Unit will be forced operate in  (COOL) with SUPER HI fan speed for 20 minutes.  Indicator appear during this period while temperature and fan speed setting display remain unchanged. (Operation lamp at indoor unit is blinking).
- After 20 minutes, operation lamp stop blinking and  indicator will disappear while unit will be in  (COOL) mode. Temperature and fan speed will change to previous setting.
- Air blow sound will be slightly high due to forced operation.



## CANCELLATION of SUPER COOLING Operation

Cancel Condition	Operation mode after cancel
Press  or OFF timer time is up	Stop operation
 key press	DEHUMIDIFYING operation
Press  or Press  or Press  or Press  or Press  or 20 minutes time is up	Normal COOLING operation

### NOTE

- (1)  OFF TIME setting : OFF timer will be a priority over the SUPER COOLING operation time.
- (2)  ON TIME setting : SUPER COOLING operation will be a priority over the ON timer operation time.

# SUPER SILENT

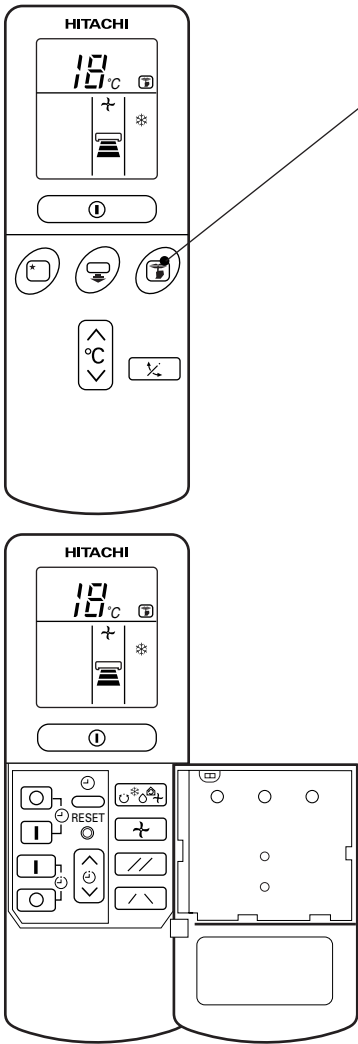





1

Press the  button.

- Operation start with a signal received sound “beep”.
- Unit will be forced operate in any operation mode as before with SUPER SILENT fan speed. The indication of operation mode, temperature setting, fan speed and timer value on remote controller will remain no change.

## CANCELLATION of SUPER SILENT Operation

Cancel Condition	Operation mode after cancel
Press  button. OFF timer time is up Sleeping timer time is up	Stop operation
Press  SUPER COOL button	SUPER COOL operation
Press  button	Next fan speed operation
Press  SUPER SILENT button.	Existing operation mode

**NOTE:**

Under SUPER SILENT operation and quiet environment, phenomena like flowing noise of refrigerant in the refrigerating cycle may occur, but this is normal for the operation.

# HOW TO SET THE TIMER

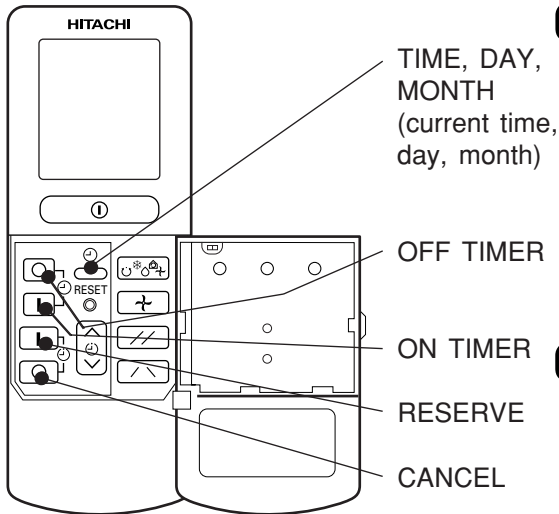

## Time, Day, Month

After you change the batteries;

**1** Set the current month and day with the TIMER control button.

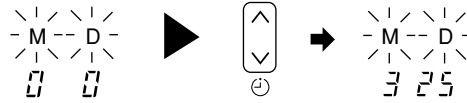

## OFF-Timer

**1** Press the (OFF-TIMER) button. The (OFF) mark blinks on the display.

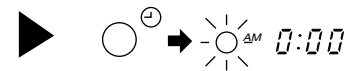
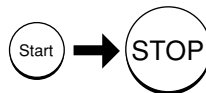

You can set the device to turn off at the present time.

## ON-Timer

- The device will turn on at the designated times.

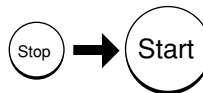

**1** Press the (ON-TIMER) button the (ON) mark blinks on the display.

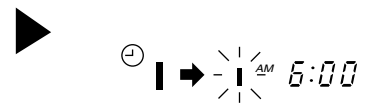

## ON/OFF-Timer

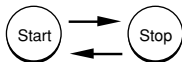

- The device will turn on (off) and off (on) at the designated times.
- The switching occurs first at the preset time that comes earlier.
- The arrow mark appearing on the display indicates the sequence of switching operations.

**1** Press the (ON-OFF) button so that the (OFF) mark blinks.

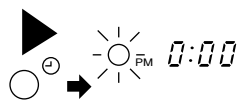

**2** Set the turn-off time with the TIMER control button. Press the (RESERVE) button.

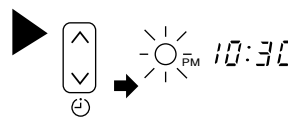

**3** Press the (ON-TIMER) button so that the (OFF) mark lights and the (ON) mark blinks.

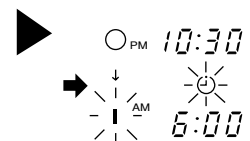

## How to Cancel Reservation

Point the signal window of the remote controller toward the indoor unit, and press the (CANCEL) button.

The (RESERVED) sign goes out with a beep and the (TIMER) lamp turns off on the indoor unit.

## NOTE

You can set only one of the OFF-timer, ON-timer and ON/OFF-timer.

**2** Set the ⊕ (TIME) button.

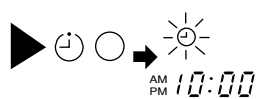

**3** Set the current time with the TIMER control button.

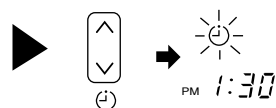

**4** Press the ⊕ (TIME) button again. The time indication starts lighting instead of flashing.

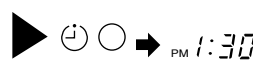

- The time indication will disappear automatically in 1 second.
  - To check the current time setting, press the ⊕ (TIME) button twice.
- The setting of the current time is now complete.

Example: The current time is 1:30 p.m.

**2** Set the turn-off time with the TIMER control button.

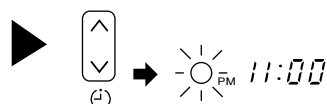

**3** Point the signal window of the remote controller toward the indoor unit, and press the | (RESERVE) button. The ⊖ (OFF) mark starts lighting instead of flashing and the sign ⊕ (RESERVED) lights. A beep occurs and the ⊕ (TIMER) lamp lights on the indoor unit.



Example: The device will turn off at 11:00p.m.

The setting of turn-off time is now complete.

**2** Set the turn-on time with the TIMER control button.

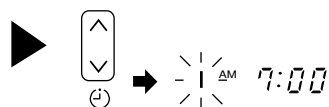

**3** Point the signal window of the remote controller toward the indoor unit, and press the | (RESERVE) button. The | (ON) mark starts lighting instead of flashing and the ⊕ (RESERVED) sign lights. A beep occurs and the ⊕ (TIMER) lamp lights on the indoor unit.



Example:  
The device will turn on, early so that the preset temperature be almost reached at 7:00 a.m.  
The setting of the turn-on time is now complete.

**4** Set the turn-on time with the TIMER control button.

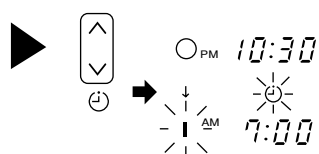

**5** Point the signal window of the remote controller toward the indoor unit, and press the | (RESERVE) button. The | (ON) mark starts lighting instead of flashing and the ⊕ (RESERVED) sign lights. A beep occurs and the ⊕ (TIMER) lamp lights on the indoor unit.

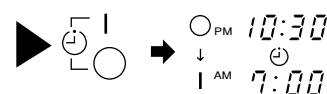

Example:  
For heating, the device will turn off at 10:30p.m., and then turn on early so that the preset temperature be almost reached at 7.00a.m.; for cooling and dehumidifying, it will simply turned on at 7.00a.m. The settings of the turn on/off times are now complete.

- The timer may be used in three ways: off-timer, on-timer, and ON/OFF (OFF/ON)-timer. Set the current time at first because it serves as a reference.
- As the time settings are stored in memory in the remote controller, you only have to press the | (RESERVE) button in order to use the same settings next time.

## HOW TO SET THE SLEEP TIMER

Set the current time at first if it is not set before (see the pages for setting the current time). Press the  (SLEEP) button, and the display changes as shown below.

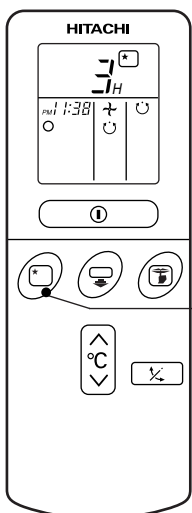

• SLEEP

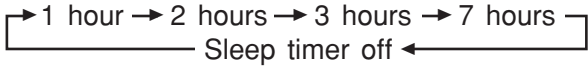
Mode	Indication
Sleep timer	

**Sleep Timer:** The device will continue working for the designated number of hours and then turn off. Point the signal window of the remote controller toward the indoor unit, and press the SLEEP button. The timer information will be displayed on the remote controller. The TIMER lamp lights with a beep from the indoor unit. When the sleep timer has been set, the display indicates the turn-off time.

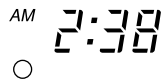

Example: If you set 3 hours sleep time at 11:38 p.m., the turn-off time is 2:38 a.m.

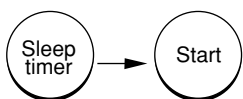

The device will be turned off by the sleep timer and turned on by on-timer.

**1** Set the ON-timer.

**2** Press the  (SLEEP) button and set the sleep timer.

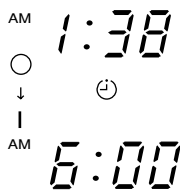
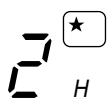

Example:

In this case, the device will turn off in 2 hours (at 1:38 a.m.) and starts at 6:00 a.m. next morning.

### How to Cancel Reservation

Point the signal window of the remote controller toward the indoor unit, and press the  (CANCEL) button.

The  (RESERVED) sign goes out with a beep and the  (TIMER) lamp turns off on the indoor unit.

## Explanation of the sleep timer

The device will control the FAN SPEED and room temperature automatically so as to be quiet and good for people's health.

You can set the sleep timer to turn off after 1, 2, 3 or 7 hours. The FAN SPEED and room temperature will be controlled as shown below.

### Operation with the sleep timer

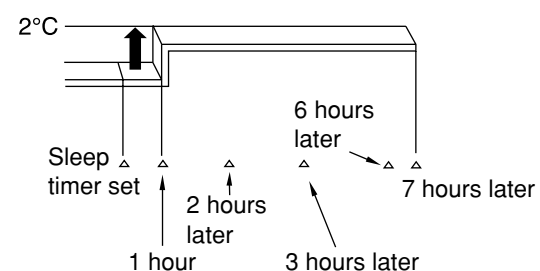
Function	Operation
Cooling “ ❄ ” and dehumidifying “ 💧 ”	<p>The room temperature will be controlled 2°C above the temperature and the FAN SPEED will be set to LOW setting 1 hour after the setting of the sleep timer.</p> 
Fan “ ✂ ”	<p>The settings of room temperature and circulation are varied.</p>

#### NOTE

- If date or current time is not set, sleep timer can not be set.
- If you set the sleep timer after the off-, on/off- or off/on-timer has been set, the sleep timer becomes effective instead of the off-, on/off- or off/on-timer set earlier.
- You can not set other timer during sleep timer operation.
- After sleep timer time is up and when press sleep button again, the sleep timer will be set as last setting.
- Sleep timer effective only once.

# ADJUSTING THE AIR DEFLECTOR

## 1 Adjustment of the conditioned air in the upward and downward directions.

The horizontal air deflector is automatically set to the proper angle suitable for each operation. The deflector can be swung up and down continuously and also set to the desired angle using the “ (AUTO SWING)” button.

- If the “ (AUTO SWING)” button is pressed once, the horizontal air deflector swings up and down. If the button is pressed again, the deflector stops in its current position. Several seconds (about 6 seconds) may be required before the deflector starts to move.
- Use the horizontal air deflector within the adjusting range shown on the right.
- When the operation is stopped, the horizontal air deflector moves and stops at the position where the air outlet closes.

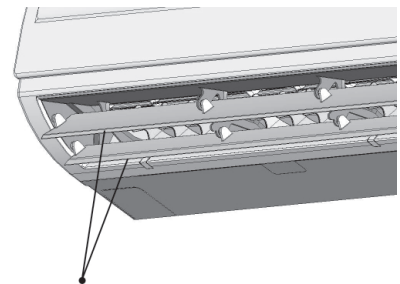
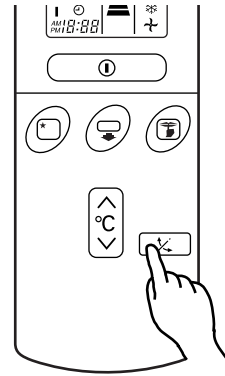

### CAUTION

- In “Cooling” operation, do not keep the horizontal and vertical air deflector swinging for a long time. Some dew may form on the horizontal and vertical air deflector and dew may drop.



Horizontal air deflector

## 2 Adjustment of the conditioned air in the left and right directions.

- If the “ (PARALLEL SWING)” button is pressed once, the vertical air deflectors swing left and right to parallel. If the button is pressed again, the deflectors stop in their current position. Several second (about 6 seconds) may be required before the deflectors start to move.
- If the “ (SYMMETRY SWING)” button is pressed once, the vertical air deflectors swing left and right to symmetry. If the button is pressed again, the deflectors stop in their current position. Several seconds (about 6 seconds) may be required before the deflectors start to move.

### ● PARALLEL SWING

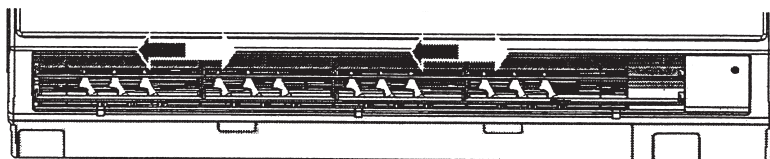

### ● SYMMETRY SWING

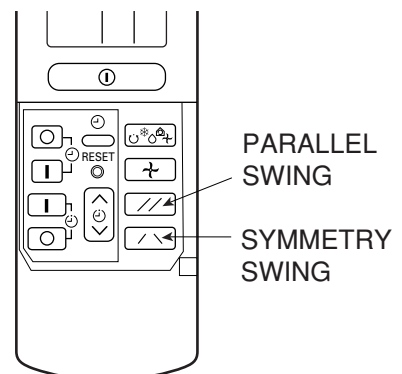
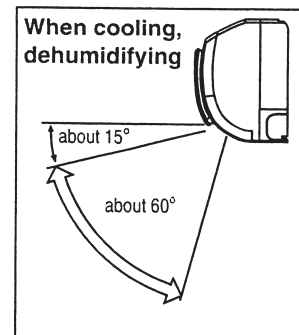
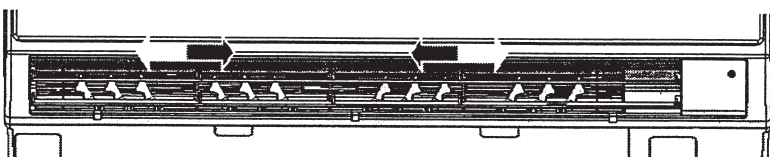

# HOW TO EXCHANGE THE BATTERIES IN THE REMOTE CONTROLLER

**1** Remove the cover as shown in the figure and take out the old batteries.



**2** Install the new batteries.  
The direction of the batteries should match the marks in the case.

**CAUTION**

- 1. Do not use new and old batteries, or different kinds of batteries together.
- 2. Take out the batteries when you do not use the remote controller for 2 or 3 months.

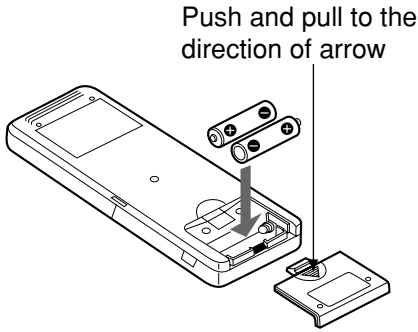

# THE IDEAL WAYS OF OPERATION

## Suitable Room Temperature

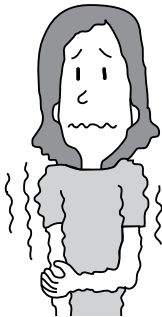

**⚠ Warning**  
Freezing temperature is bad for health and a waste of electric power.

## Install curtain or blinds

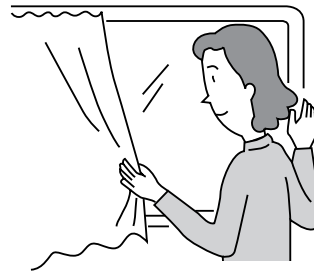

It is possible to reduce heat entering the room through windows.

## Ventilation

**⚠ Caution**  
Do not close the room for a long period of time. Occasionally open the door and windows to allow the entrance of fresh air.



## Effective Usage Of Timer

At night, please use the “sleep timer operation mode”, together with your wake up time in the morning. This will enable you to enjoy a comfortable room temperature. Please use the timer effectively.

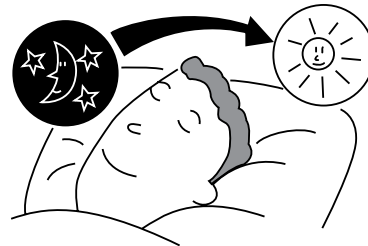

## Do Not Forget To Clean The Air Filter

Dusty air filter will reduce the air volume and the cooling efficiency. To prevent from wasting electric energy, please clean the filter every 2 weeks.

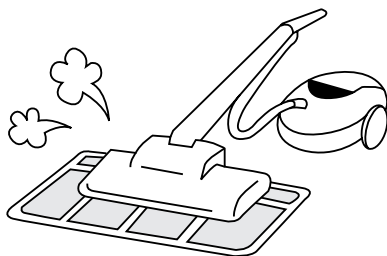

## Please Adjust Suitable Temperature For Baby And Children

Please pay attention to the room temperature and air flow direction when operating the unit for baby, children and old folks who have difficulty in movement.

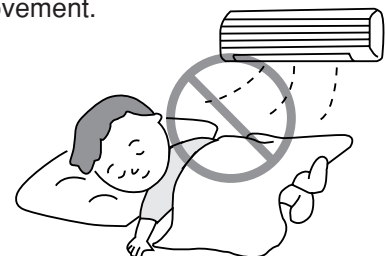

## The Air Conditioner And The Heat Source In The Room

### **Caution**

If the amount of heat in the room is above the cooling capability of the air conditioner (for example: more people entering the room, using heating equipments and etc.), the preset room temperature cannot be achieved.

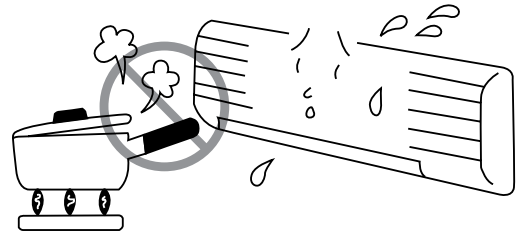

## Not Operating For A Long Time

When the indoor unit is not to be used for a long period of time, please switch off the power from the mains. If the power from mains remains "ON", the indoor unit still consumes about 8W in the operation control circuit even if it is in "OFF" mode.

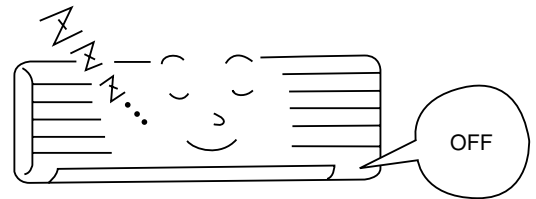

## When Lightning Occurs

### **Warning**

To protect the whole unit during lightning, please stop operating the unit and remove the plug from the socket.

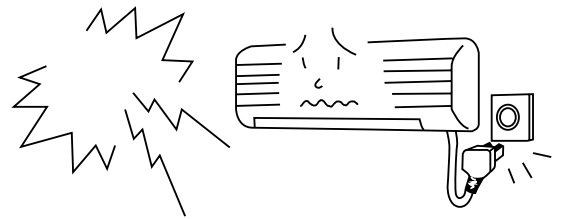

## UV-LED

UV-LED will be "ON" when the START/STOP button is pressed. Light UV glare is visible when the UV-LED is "ON" and this is normal (not malfunction).

## Interference From Electrical Products

### **Caution**

To avoid noise interference, please place the indoor unit and its remote controller at least 1m away from electrical products.

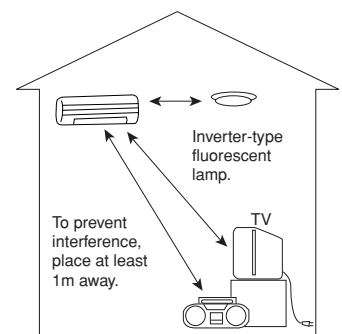

# ATTACHING THE AIR CLEANSING AND DEODORIZING FILTERS

## ⚠ CAUTION

Cleaning and maintenance must be carried out only by qualified service personal. Before cleaning, stop operation and switch off the power supply.

### 1 Open the front panel.

- Pull up the front panel by holding it at both sides with both hands.

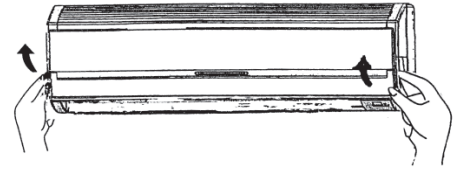

### 2 Remove the filter.

- Push upward to release the claws and pull out the filter.

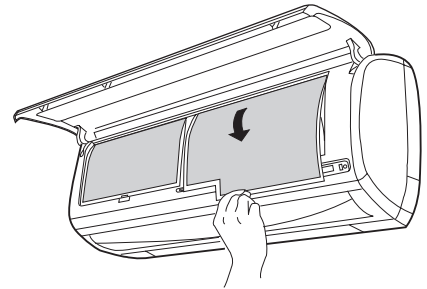

### 3 Attaching the air cleansing filters to the filter.

- Attach the air cleansing filters to the frame by gently compress its both sides and release after insertion into filter frame.

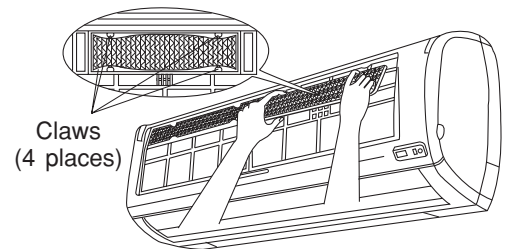

## ⚠ CAUTION

Do not bend the air cleansing filter as it may cause damage to the structure.

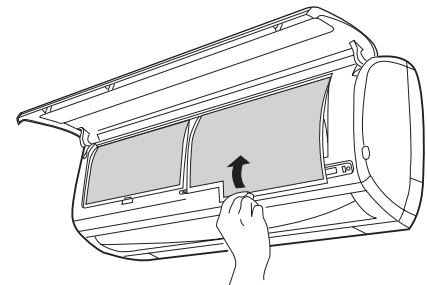

### 4 Attach the filters.

- Attach the filters by ensuring that the surface written "FRONT" is facing front.
- After attaching the filters, push the front panel at three arrow portion as shown in figure and close it.



## NOTE

- In case of removing the air cleansing filters, please follow the above procedures.
- The cooling capacity is slightly weakened and the cooling speed becomes slower when the air cleansing filters are used. So, set the fan speed to "HIGH" when using it in this condition.
- Air cleansing filters are not washable, clean by using vacuum cleaner, expose under sunlight for a day and can be use up to 1 year. Type number for this air cleansing filter is <SPX-CFH19>. Please use this number for ordering when you want to renew it.
- Do not operate the air conditioner without filter. Dust may enter the air conditioner and fault may occur.

**▲ CAUTION**

Cleaning and maintenance must be carried out only by qualified service personal. Before cleaning, stop operation and switch off the power supply.

## 1. AIR FILTER

Clean the air filter, as it removes dust inside the room. In case the air filter is full of dust, the air flow will decrease and the cooling capacity will be reduced. Further, noise may occur. Be sure to clean the filter following the procedure below.

### PROCEDURE

- 1** Open the front panel and remove the filter
- Gently lift and remove the air cleansing filter from the air filter frame.

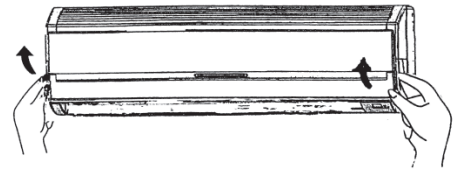

- 2** Vacuum dust from the air filter and air cleansing filter using vacuum cleaner. If there is too much dust, rinse under running tap water and gently brush it with soft bristle brush. Allow filters to dry in shade.

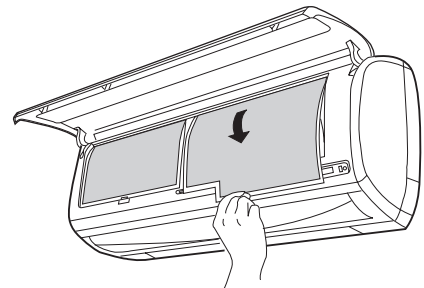
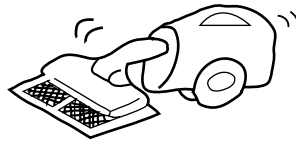

- 3**
- Re-insert the air cleansing filter to the filter frame. Set the filter with "FRONT" mark facing front, and slot them into the original state.
  - After attaching the filters, push the front panel at three arrow portions as shown in figure and close it.



**NOTE:**

- Air cleansing filter should be cleaned every month or sooner if noticeable loading occurs. When used overtime, it may loose its deodorizing function. For maximum performance, it is recommended to replace it every 1 year depending on application requirements.

**▲ CAUTION**

- Do not wash with hot water at more than 40°C. The filter may shrink.
- When washing it, shake off moisture completely and dry it in the shade; do not expose it directly to the sun. The filter may shrink.
- Do not use detergent on the air cleansing filter as some detergent may deteriorate the filter electrostatic performance.

**Attaching the negative ion stick to the filter frame.**

- Put the negative ion stick to the lower hooks and install it so as to push up the upper hooks at the left side of front cover.  
(Negative ion provided with this unit = 1 piece)

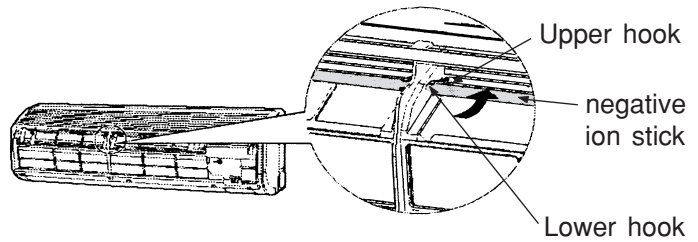

**2. Washable Front Panel**

- Remove the front panel and wash with clean water.  
Wash it with a soft sponge.  
After using neutral detergent, wash thoroughly with clean water.
- When front panel is not removed, wipe it with a soft dry cloth. Wipe the remote controller thoroughly with a soft dry cloth.
- Wipe the water thoroughly.  
If water remains at indicators or signal receiver of indoor unit, it causes trouble.

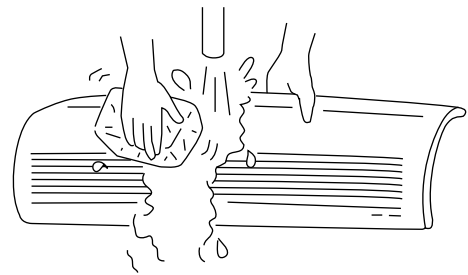

Method of removing the front panel.  
Be sure to hold the front panel with both hands to detach and attach it.

**Removing the Front Panel**

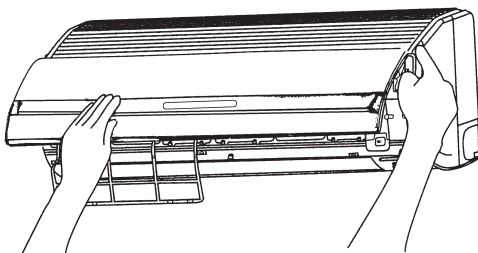

- When the front panel is fully opened with both hands, push the right arm to the inside to release it, and while closing the front panel slightly, put it out forward.

**Attaching the Front Panel**

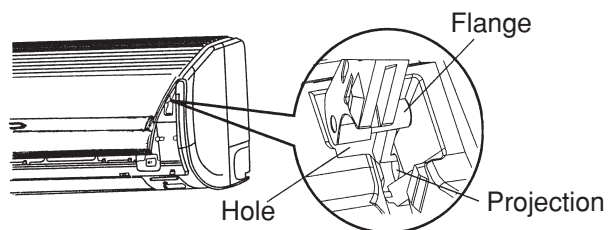

- Move the projections of the left and right arms into the **Flanges** in the unit and securely insert them into the holes.

**CAUTION**

- Do not splash or direct water to the body of the unit when cleaning it as this may cause short circuit.
- Never use hot water (above 40°C), benzine, gasoline, acid, thinner or a brush, because they will damage the plastic surface and the coating.



**CAUTION**

Cleaning and maintenance must be carried out only by qualified service personal. Before cleaning, stop operation and switch off the power supply.

**3. MAINTENANCE AT BEGINNING OF LONG OFF PERIOD**

- Run the unit by setting the operation mode to ❄️ (COOL), the temperature to 32°C and the fan speed to HI for about half a day on a fine day, and dry the whole of the unit.
- Switch off the power plug.

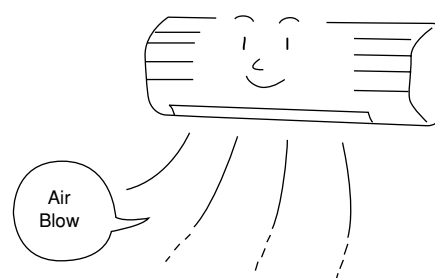

**Note :**

If the supply cord is damaged, it must be replaced by the manufacturer, its service agent or similarly qualified persons in order to avoid a hazard.

**REGULAR INSPECTION**

PLEASE CHECK THE FOLLOWING POINTS BY QUALIFIED SERVICE PERSONAL EITHER EVERY HALF YEARLY OR YEARLY. CONTACT YOUR SALES AGENT OR SERVICE SHOP.

<p><b>1</b></p>		<p>Is the earth line disconnected or broken?</p>
<p><b>2</b></p>		<p>Is the mounting frame seriously affected by rust and is the outdoor unit tilted or unstable?</p>
<p><b>3</b></p>		<p>Is the plug of power line firmly plugged into the socket? (Please ensure no loose contact between them).</p>

# AFTER SALE SERVICE AND WARRANTY

## WHEN ASKING FOR SERVICE, CHECK THE FOLLOWING POINTS.

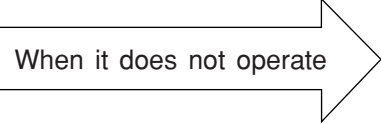
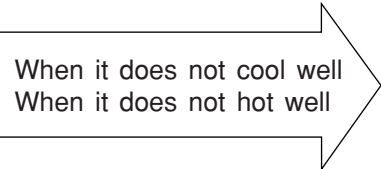
CONDITION	CHECK THE FOLLOWING POINTS
 <p>When it does not operate</p>	<ul style="list-style-type: none"> <li>● Is the fuse all right?</li> <li>● Is the voltage extremely high or low?</li> <li>● Is the circuit breaker "ON"?</li> </ul>
 <p>When it does not cool well When it does not hot well</p>	<ul style="list-style-type: none"> <li>● Was the air filter cleaned?</li> <li>● Does sunlight fall directly on the outdoor unit?</li> <li>● Is the air flow of the outdoor unit obstructed?</li> <li>● Are the doors or windows opened, or is there any source of heat in the room?</li> <li>● Is the set temperature suitable?</li> </ul>



### Notes

- In quiet operation or stopping the operation, the following phenomena may occasionally occur, but they are not abnormal for the operation.
  - (1) Slight flowing noise of refrigerant in the refrigerating cycle.
  - (2) Slight rubbing noise from the fan casing which is cooled and then gradually warmed as operation stops.
- The odor will possibly be emitted from the room air conditioner because the various odor, emitted by smoke, foodstuffs, cosmetics and so on, sticks to it. So the air filter and the evaporator regularly must be cleaned to reduce the odor.

- Please contact your sales agent immediately if the air conditioner still fails to operate normally after the above inspections. Inform your agent of the model of your unit, production number, date of installation. Please also inform him regarding the fault.
- Power supply shall be connected at the rated voltage, otherwise the unit will be broken or could not reach the specified capacity.



