

HITACHI

Inspire the Next

SPLIT TYPE AIR CONDITIONER

INDOOR UNIT/OUTDOOR UNIT

MODEL

RAS-19SH4/RAC-19SH4

OUTDOOR UNIT

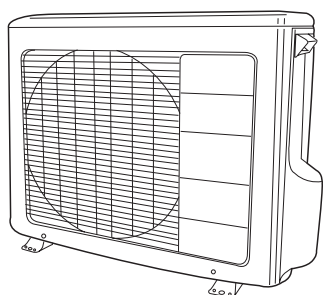

RAC-19SH4

INDOOR UNIT

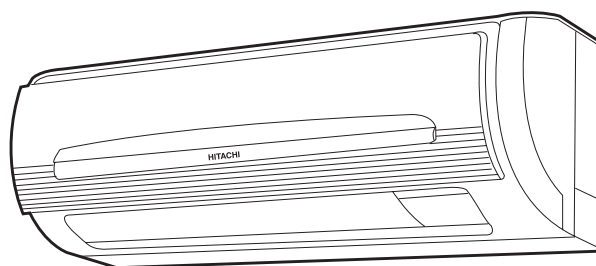

RAS-19SH4



Instruction manual

Page 1~26

To obtain the best performance and ensure years of trouble free use, please read this instruction manual completely.

Bedienungsanleitung

Suite 27~52

Bitte lesen Sie diese Bedienungsanleitung aufmerksam durch, um durch richtige Bedienung jahrelangen und störungsfreien Betrieb zu gewährleisten.

Mode d'emploi

Page 53~78

Des performances optimales et un fonctionnement à long terme seront assurés en appliquant les présentes instructions après avoir entièrement lu ce mode d'emploi.

Manuale di istruzioni

Pag. 79~104

Per garantire la migliore prestazione e la più lunga duratateleggere attentamente e al completo le seguenti istruzioni.

Manual de instrucciones

Página 105~130

Para obtener el mejor funcionamiento y asegurar años de uso libre de problemas, lea cuidadosamente este manual de instrucciones.

Manual de instruções

Página 131~156

A fim de obter um bom funcionamento e de garantir uma utilização sem falhas durante muitos anos, é favor ler este manual de instruções completamente.

Οδηγίες Χειρισμού



Σελίδα 157~182

°ια την καλύτερη δυνατή α όδοση και την μακροχρόνια και χωρίς ροβλήματα χρήση της συσκευής αυτής, αρακαλούμε διαβάστε λήρως τις οδηγίες χειρισμού της.







SAFETY PRECAUTION

- Please read the “Safety Precaution” carefully before operating the unit to ensure correct usage of the unit.
- Pay special attention to signs of “▲ Warning” and “▲ Caution”. The “Warning” section contains matters which, if not observed strictly, may cause death or serious injury. The “Caution” section contains matters which may result in serious consequences if not observed properly. Please observe all instructions strictly to ensure safety.
- The sign indicate the following meanings.

 Make sure to connect earth line.	 The sign in the figure indicates prohibition.
 Indicates the instructions that must be followed.	

- Please keep this manual after reading.



PRECAUTIONS DURING INSTALLATION

 WARNING	<ul style="list-style-type: none"> ● Do not reconstruct the unit. Water leakage, fault, short circuit or fire may occur if you reconstruct the unit by yourself. 	
	<ul style="list-style-type: none"> ● Please ask your sales agent or qualified technician for the installation of your unit. Water leakage, short circuit or fire may occur if you install the unit by yourself. 	
 CAUTION	<ul style="list-style-type: none"> ● Please use earth line. Do not place the earth line near water or gas pipes, lightning-conductor, or the earth line of telephone. Improper installation of earth line may cause electric shock. 	
	<ul style="list-style-type: none"> ● A circuit breaker should be installed depending on the mounting site of the unit. Without a circuit breaker, the danger of electric shock exists. 	
	<ul style="list-style-type: none"> ● Do not install near location where there is flammable gas. The outdoor unit may catch fire if flammable gas leaks around it. ● Please ensure smooth flow of water when installing the drain hose. 	

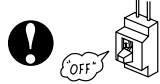
PRECAUTIONS DURING SHIFTING OR MAINTENANCE

 WARNING	<ul style="list-style-type: none"> ● Should abnormal situation arises (like burning smell), please stop operating the unit and turn off the circuit breaker. Contact your agent. Fault, short circuit or fire may occur if you continue to operate the unit under abnormal situation. 	
	<ul style="list-style-type: none"> ● Please contact your agent for maintenance. Improper self maintenance may cause electric shock and fire. 	
	<ul style="list-style-type: none"> ● Please contact your agent if you need to remove and reinstall the unit. Electric shock or fire may occur if you remove and reinstall the unit yourself improperly. 	

PRECAUTIONS DURING OPERATION

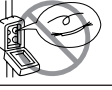
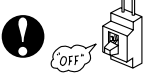
 WARNING	<ul style="list-style-type: none"> ● Avoid an extended period of direct air flow for your health. 	
	<ul style="list-style-type: none"> ● Do not insert a finger, a rod or other objects into the air outlet or inlet. As the fan is rotating at a high speed, it will cause injury. Before cleaning, be sure to stop the operation and turn the breaker OFF. 	
	<ul style="list-style-type: none"> ● Do not use any conductor as fuse wire, this could cause fatal accident. 	
	<ul style="list-style-type: none"> ● During thunder storm, disconnect and turn off the circuit breaker. 	

PRECAUTIONS DURING OPERATION

- The product shall be operated under the manufacturer specification and not for any other intended use.

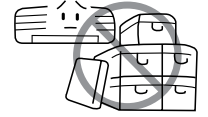

- Do not attempt to operate the unit with wet hands, this could cause fatal accident.

- When operating the unit with burning equipments, regularly ventilate the room to avoid oxygen insufficiency.

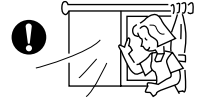

- Do not direct the cool air coming out from the air-conditioner panel to face household heating apparatus as this may affect the working of apparatus such as the electric kettle, oven etc.

- Please ensure that outdoor mounting frame is always stable, firm and without defect. If not, the outdoor unit may collapse and cause danger.



- Do not splash or direct water to the body of the unit when cleaning it as this may cause short circuit.



C
A
U
T
I
O
N

- Do not use any aerosol or hair sprays near the indoor unit. This chemical can adhere on heat exchanger fin and blocked the evaporation water flow to drain pan. The water will drop on tangential fan and cause water splashing out from indoor unit.

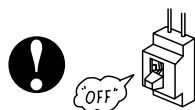

- Please switch off the unit and turn off the circuit breaker during cleaning, the high-speed fan inside the unit may cause danger.

- Turn off the circuit breaker if the unit is not to be operated for a long period.



- Do not climb on the outdoor unit or put objects on it.

- Do not put water container (like vase) on the indoor unit to avoid water dripping into the unit. Dripping water will damage the insulator inside the unit and causes short-circuit.



- Do not place plants directly under the air flow as it is bad for the plants.

- When operating the unit with the door and windows opened, (the room humidity is always above 80%) and with the air deflector facing down or moving automatically for a long period of time, water will condense on the air deflector and drips down occasionally. This will wet your furniture. Therefore, do not operate under such condition for a long time.
- If the amount of heat in the room is above the cooling or heating capability of the unit (for example: more people entering the room, using heating equipments and etc.), the preset room temperature cannot be achieved.

NAMES AND FUNCTIONS OF EACH PART

INDOOR UNIT

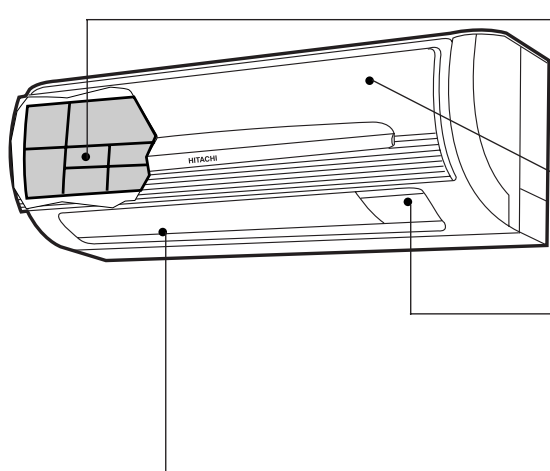

Air filter

To prevent dust from coming into the indoor unit.
(Refer page 21)

Front panel

Indoor unit indicators

Light indicator showing the operating condition.
(Refer page 5)

**Horizontal deflector • Vertical deflector
(Air Outlet)**

(Refer page 16)



Remote controller

Send out operation signal to the indoor unit. So as to operate the whole unit.
(Refer page 6)

OUTDOOR UNIT

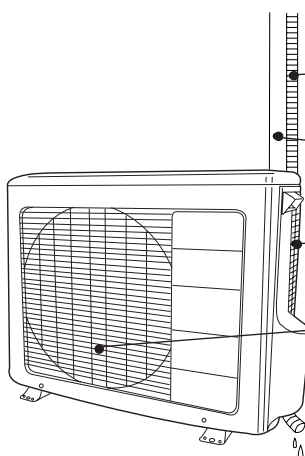

DRAIN PIPE

Condensed water drain to outside.

CONNECTING CORD

AIR INLET (BACK, LEFT SIDE)

AIR OUTLET

MODEL NAME AND DIMENSIONS

MODEL	WIDTH (mm)	HEIGHT (mm)	DEPTH (mm)
RAS-19SH4	780	280	210
RAC-19SH4	850	650	298

INDOOR UNIT INDICATORS

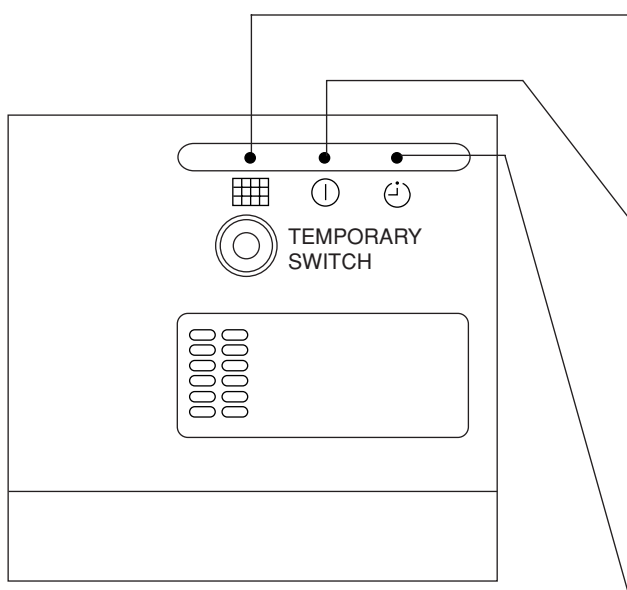

FILTER LAMP

When the device is operated for a total of about 100 hours, the FILTER lamp lights to indicate that it is time to clean the filter. The lamp goes out when the POWER SWITCH set to OFF and ON again.

OPERATION LAMP

This lamp lights during operation.

The OPERATION LAMP flashes in the following cases during heating.

(1) During preheating

For about 2–3 minutes after starting up.

(2) During defrosting

Defrosting will be performed about once every one hour when frost forms on the heat exchanger of the outdoor unit, for 5–10 minutes each time.

TIMER LAMP

This lamp lights when the timer is working.

OPERATION INDICATOR

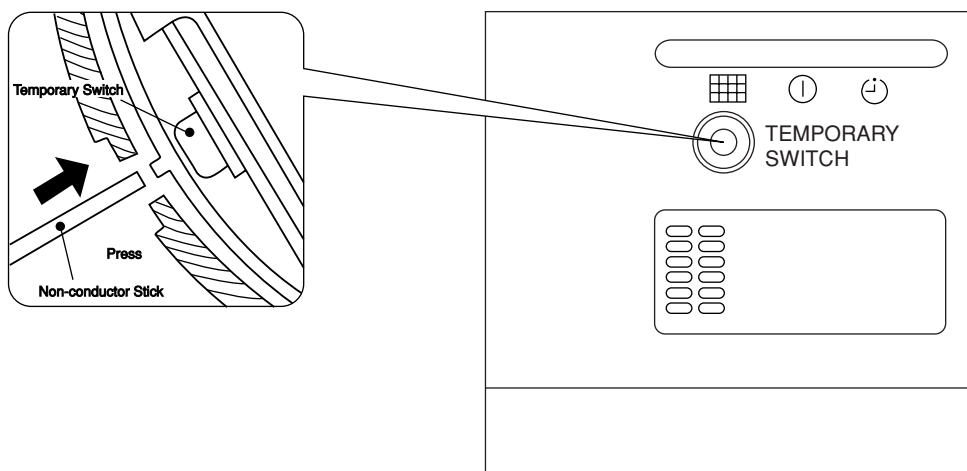

TEMPORARY SWITCH

Use this switch to start and stop when the remote controller does not work. [Use non-conductor stick (example toothpick)]

- By pressing the temporary switch, the operation is done in previously set operation mode.
- When the operation is done using the temporary switch after the power source is turned off and turn on again, the operation is done in automatic mode.

NAMES AND FUNCTIONS OF REMOTE CONTROL UNIT

REMOTE CONTROLLER

- This controls the operation of the indoor unit. The range of control is about 7 meters. If indoor lighting is controlled electronically, the range of control may be shorter.
This unit can be fixed on a wall using the fixture provided. Before fixing it, make sure the indoor unit can be controlled from the remote controller.
- Handle the remote controller with care. Dropping it or getting it wet may compromise its signal transmission capability.
- After new batteries are inserted into the remote controller, the unit will initially require approximately 10 seconds to respond to commands and operate.

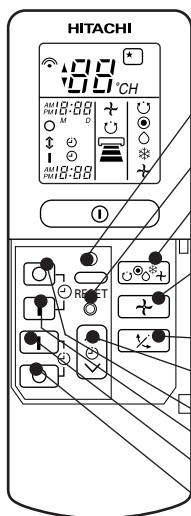
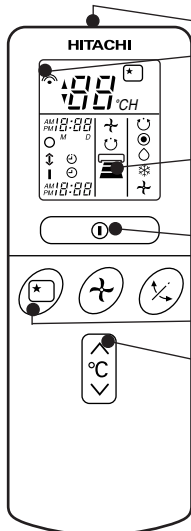

- **Signal emitting window/transmission sign**
Point this window toward the indoor unit when controlling it. The transmission sign blinks when a signal is sent.
- **Display**
This indicates the room temperature selected, current time, timer status, function and intensity of circulation selected.
- **START/STOP button**
Press this button to start operation. Press it again to stop operation.
- **SLEEP button**
Use this button to set the sleep timer.
- **TEMPERATURE buttons**
Use these buttons to raise or lower the temperature setting. (Keep pressed, and the value will change more quickly.)
- **TIME button**
Use this button to set and check the time and date.
- **RESET buttons**
- **FUNCTION selector**
Use this button to select the operating mode. Every time you press it, the mode will change from ☺ (AUTO) to ● (HEAT) to ○ (DEHUMIDIFY) to ❄ (COOL) and to ✈ (FAN) cyclically.
- **FAN SPEED selector**
This determines the fan speed. Every time you press this button, the intensity of circulation will change from ☺ (AUTO) to 🌀 (HI) to 🌀 (MED) to 🌀 (LOW) (This button allows selecting the optimal or preferred fan speed for each operation mode).
- **AUTO SWING button**
Controls the angle of the horizontal air deflector.
- **TIMER control**
Use this button to set the timer.
- **OFF-TIMER button** Select the turn OFF time.
- **ON-TIMER button** Select the turn ON time.
- **RESERVE button** Time setting reservation.
- **CANCEL button** Cancel time reservation.

☺	AUTO
●	HEAT
○	DEHUMIDIFY
❄	COOL
✈	FAN
🌀	FAN SPEED LOW MED HI
★	SLEEPING
○	STOP (CANCEL)
I	START (RESERVE)
①	START/STOP
⌚	TIME
⌚	TIMER SET
⌚	TIMER SELECTOR ON TIMER OFF TIMER
✂	AUTO SWING

Precautions for Use

- Do not put the remote controller in the following places.
 - Under direct sunlight.
 - In the vicinity of a heater.
- Handle the remote controller carefully. Do not drop it on the floor, and protect it from water.
- Once the outdoor unit stops, it will not restart for about 3 minutes (unless you turn the power switch off and on or unplug the power cord and plug it in again).
This is to protect the device and does not indicate a failure.
- If you press the FUNCTION selector button during operation, the device may stop for about 3 minutes for protection.

VARIOUS FUNCTIONS

■ Auto Restart Control

- If there is a power failure, operation will be automatically restarted when the power is resumed with previous operation mode and airflow direction.
(As the operation is not stopped by remote controller.)
- If you intend not to continue the operation when the power is resumed, switch off the power supply.
When you switch on the circuit breaker, the operation will be automatically restarted with previous operation mode and airflow direction.

Note: 1. If you do not require Auto Restart Control, please consult your sales agent or OFF by remote control.
2. Auto Restart Control is not available when Timer or Sleep Timer mode is set.

AUTOMATIC OPERATION

The device will automatically determine the mode of operation, HEAT, COOL or DEHUMIDIFY depending on the current room temperature. The selected mode of operation will change when the room temperature varies. However the mode of operation will not change when indoor unit connected to multi type outdoor unit.

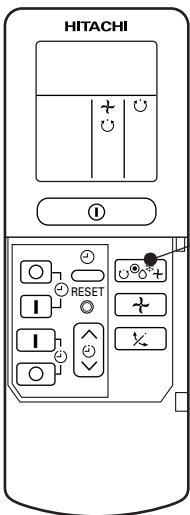

Press the FUNCTION selector so that the display indicates the  (AUTO) mode of operation.

- When AUTO has been selected, the device will automatically determine the mode of operation, HEAT, COOL or DEHUMIDIFY depending on the current room temperature. However the mode of operation will not change when indoor unit connected to multi type outdoor unit.
- If the mode automatically selected by the unit is not satisfactory, manually change the mode setting (heat, dehumidify, cool or fan).

START STOP

Press the  (START/STOP) button.
Operation starts with a beep.
Press the button again to stop operation.

- As the settings are stored in memory in the remote controller, you only have to press the  (START/STOP) button next time.

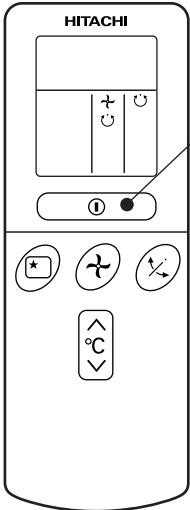

You can raise or lower the temperature setting as necessary by maximum of 3°C.

 Press the temperature button and the temperature setting will change by 1°C each time.

- The preset temperature and the actual room temperature may vary somewhat depending on conditions.
- The display does not indicate the preset temperature in the AUTO mode.
If you change the setting, the indoor unit will produce a beep.

Press the  (FAN SPEED) button, AUTO and LOW is available.

HEATING OPERATION

- Use the device for heating when the outdoor temperature is under 21°C.
When it is too warm (over 21°C), the heating function may not work in order to protect the device.
- In order to keep reliability of the device, please use this device above -15°C of the outdoor temperature.

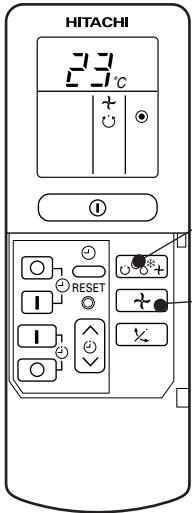

1

Press the FUNCTION selector so that the display indicates ● (HEAT).

2

Set the desired FAN SPEED with the ↻ (FAN SPEED) button (the display indicates the setting).

↻ (AUTO): The fan speed is HI at first and varies to MED automatically when the preset temperature has been reached.

⏏ (HI) : Economical as the room will become warm quickly.
But you may feel a chill at the beginning.

⏏ (MED) : Fan speed slow.

⏏ (LOW) : Fan speed slower.

3

Set the desired room temperature with the TEMPERATURE buttons (the display indicates the setting).

The temperature setting and the actual room temperature may vary somewhat depending on conditions.

**START
STOP**

Press the ⏻ (START/STOP) button. Heating operation starts with a beep. Press the button again to stop operation.

- As the settings are stored in memory in the remote controller, you only have to press the ⏻ (START/STOP) button next time.

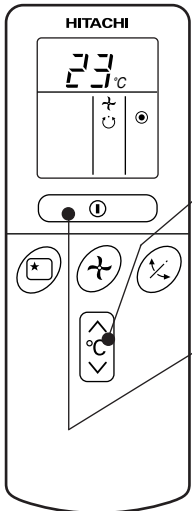

DEHUMIDIFYING OPERATION

Use the device for dehumidifying when the room temperature is over 16°C.
When it is under 15°C, the dehumidifying function will not work.

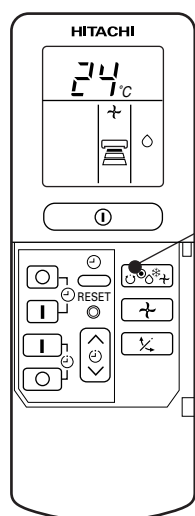

1

Press the FUNCTION selector so that the display indicates ◊ (DEHUMIDIFY).
The FAN SPEED is set at LOW automatically.
The FAN SPEED button does not work.

2

Set the desired room temperature with the TEMPERATURE button (the display indicates the setting).

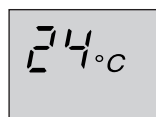

The range of 20-26°C is recommended as the room temperature for dehumidifying.

START
STOP

Press the Ⓜ (START/STOP) button. Dehumidifying operation starts with a beep. Press the button again to stop operation.

- As the settings are stored in memory in the remote controller, you only have to press the Ⓜ (START/STOP) button next time.

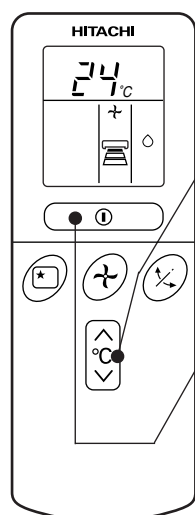

■ Dehumidifying Function

When the room temperature is higher than the temperature setting: The device will dehumidify the room, reducing the room temperature to the preset level.

When the room temperature is lower than the temperature setting: Dehumidifying will be performed at the temperature setting slightly lower than the current room temperature, regardless of the temperature setting. The function will stop (the indoor unit will stop emitting air) as soon as the room temperature becomes lower than the setting temperature.

COOLING OPERATION

Use the device for cooling when the outdoor temperature is 10-43°C.
If in doors humidity is very high (80%), some dew may form on the air outlet grille of the indoor unit.

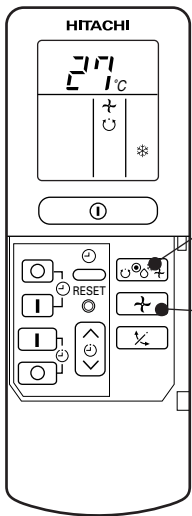

1

Press the FUNCTION selector so that the display indicates * (COOL).

Set the desired FAN SPEED with the \updownarrow (FAN SPEED) button (the display indicates the setting).

\updownarrow (AUTO): The FAN SPEED is HI at first and varies to MED automatically when the preset temperature has been reached.

 (HI) : Economical as the room will become cool quickly.

 (MED) : Fan speed slow.

 (LOW) : Fan speed slower.

2

Set the desired room temperature with the TEMPERATURE button (the display indicates the setting).

The temperature setting and the actual room temperature may vary some how depending on conditions.

3

Press the ON/OFF (START/STOP) button. Cooling operation starts with a beep. Press the button again to stop operation. The cooling function does not start if the temperature setting is higher than the current room temperature (even though the ON/OFF (OPERATION) lamp lights). The cooling function will start as soon as you set the temperature below the current room temperature.

**START
STOP**

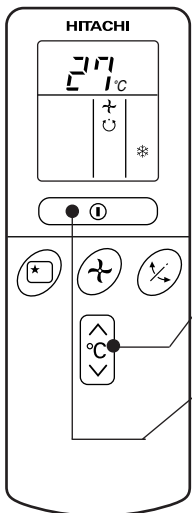

■ As the settings are stored in memory in the remote controller, you only have to press the ON/OFF (START/STOP) button next time.

FAN OPERATION

You can use the device simply as an air circulator. Use this function to dry the interior of the indoor unit at the end of summer.

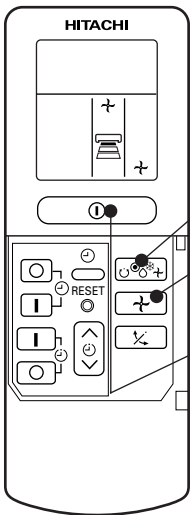

1

Press the FUNCTION selector so that the display indicates  (FAN).

2

Press the  (FAN SPEED) button.

**START
STOP**

Press the  (START/STOP) button. Fan operation starts with a beep. Press the button again to stop operation.

FAN SPEED (AUTO)

..... When the AUTO fan speed mode is set in the cooling/heating operation:

For the heating operation	<ul style="list-style-type: none"> ● The fan speed will automatically change according to the temperature of discharged air. ● When the difference of room temperature and setting temperature is large, fan starts to run at HI speed. ● When the room temperature reaches setting temperature, fan speed changes to LOW automatically.
For the cooling operation	<ul style="list-style-type: none"> ● When the difference of room temperature and setting temperature is large, fan starts to run at HI speed. ● After room temperature reaches the preset temperature, the cooling operation, which changes the fan speed and room temperature to obtain optimum conditions for natural healthful cooling will be performed.

HOW TO SET THE TIMER

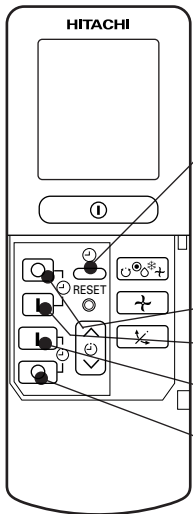

Time, Day, Month

After you change the batteries;

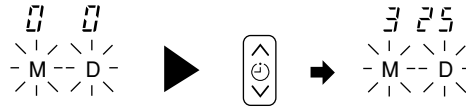

1 Set the current month and day with the TIMER control button.

OFF-Timer

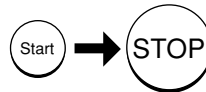

You can set the device to turn off at the present time.

1 Press the (OFF-TIMER) button. The (OFF) mark blinks on the display.

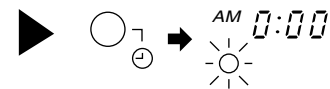

ON-Timer

- The device will turn on at the designated times.

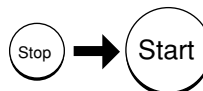

1 Press the (ON-TIMER) button the (ON) mark blinks on the display.

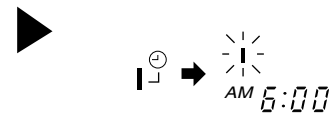

ON/OFF-Timer

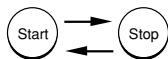

- The device will turn on (off) and off (on) at the designated times.
- The switching occurs first at the preset time that comes earlier.
- The arrow mark appearing on the display indicates the sequence of switching operations.

1 Press the (ON-OFF) button so that the (OFF) mark blinks.

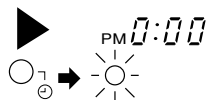

2 Set the turn-off time with the TIMER control button. Press the (RESERVE) button.

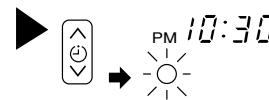

3 Press the (ON-TIMER) button so that the (OFF) mark lights and the (ON) mark blinks.

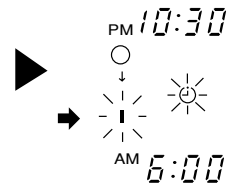

How to Cancel Reservation

Point the signal window of the remote controller toward the indoor unit, and press the (CANCEL) button.

The (RESERVED) sign goes out with a beep and the (TIMER) lamp turns off on the indoor unit.

NOTE

You can set only one of the OFF-timer, ON-timer and ON/OFF-timer.

2 Press the ⊖ (TIME) button.

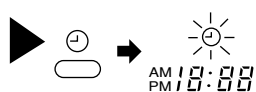

3 Set the current time with the TIMER control button.

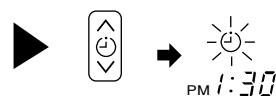

4 Press the ⊖ (TIME) button again. The time indication starts lighting instead of flashing.

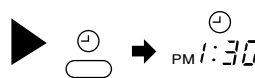

- The time indication will disappear automatically in 10 second.
- To check the current time setting, press the ⊖ (TIME) button twice.

The setting of the current time is now complete.

Example: The current time is 1:30 p.m.

2 Set the turn-off time with the TIMER control button.

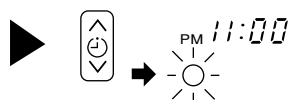

3 Point the signal window of the remote controller toward the indoor unit, and press the | (RESERVE) button.

The ○ (OFF) mark starts lighting instead of flashing and the sign ⊖ (RESERVED) lights. A beep occurs and the ⊖ (TIMER) lamp lights on the indoor unit.

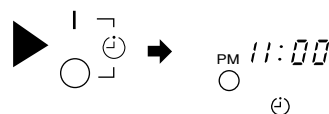

Example: The device will turn off at 11:00p.m.

The setting of turn-off time is now complete.

2 Set the turn-on time with the TIMER control button.

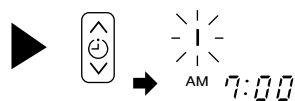

3 Point the signal window of the remote controller toward the indoor unit, and press the | (RESERVE) button.

The | (ON) mark starts lighting instead of flashing and the ⊖ (RESERVED) sign lights. A beep occurs and the ⊖ (TIMER) lamp lights on the indoor unit.

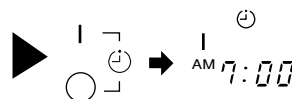

Example:
The device will turn on at 7:00 a.m.
The setting of the turn-on time is now complete.

4 Set the turn-on time with the TIMER control button.

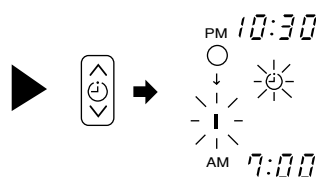

5 Point the signal window of the remote controller toward the indoor unit, and press the | (RESERVE) button.

The | (ON) mark starts lighting instead of flashing and the ⊖ (RESERVED) sign lights. A beep occurs and the ⊖ (TIMER) lamp lights on the indoor unit.

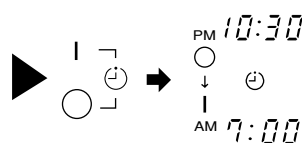

Example:
The device will turn off at 10:30 p.m. and it will be turned on at 7:00 a.m.
The settings of the turn-on/off times are now complete.

- The timer may be used in three ways: off-timer, on-timer, and ON/OFF (OFF/ON)-timer. Set the current time at first because it serves as a reference.
- As the time settings are stored in memory in the remote controller, you only have to press the | (RESERVE) button in order to use the same settings next time.

HOW TO SET THE SLEEP TIMER

Set the current time at first if it is not set before (see the pages for setting the current time). Press the  (SLEEP) button, and the display changes as shown below.

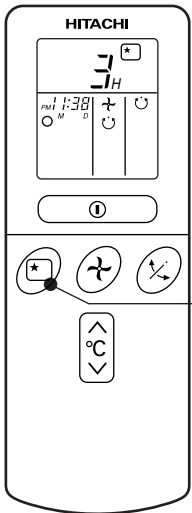

Mode	Indication
Sleep timer	

Sleep Timer: The device will continue working for the designated number of hours and then turn off. Point the signal window of the remote controller toward the indoor unit, and press the SLEEP button. The timer information will be displayed on the remote controller. The TIMER lamp lights with a beep from the indoor unit. When the sleep timer has been set, the display indicates the turn-off time.

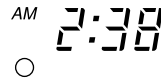

Example: If you set 3 hours sleep time at 11:38 p.m., the turn-off time is 2:38 a.m.

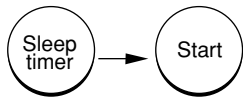

The device will be turned off by the sleep timer and turned on by on-timer.

1 Set the ON-timer.

2 Press the  (SLEEP) button and set the sleep timer.

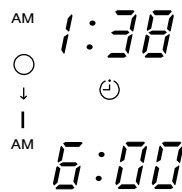
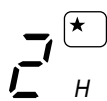



For heating:

In this case, the device will turn off in 2 hours (at 1:38 a.m.) and turn on early so that the preset temperature will be almost reached at 6:00 next morning.

How to Cancel Reservation

Point the signal window of the remote controller toward the indoor unit, and press the  (CANCEL) button.

The  (RESERVED) sign goes out with a beep and the  (TIMER) lamp turns off on the indoor unit.

Explanation of the sleep timer

The device will control the FAN SPEED and room temperature automatically so as to be quiet and good for people's health.

You can set the sleep timer to turn off after 1, 2, 3 or 7 hours. The FAN SPEED and room temperature will be controlled as shown below.

Operation with the sleep timer

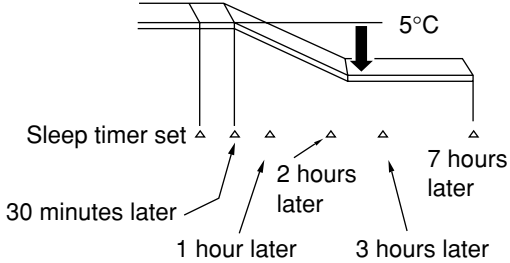
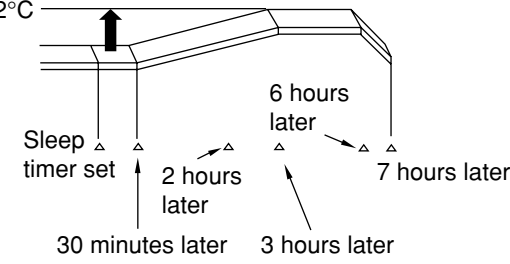
Function	Operation
<p>Heating</p> <p>“ ● ”</p>	<p>The room temperature will be controlled 5°C below the temperature and the FAN SPEED will be set to LOW setting 30 minutes after the setting of the sleep timer.</p> 
<p>Cooling and dehumidifying</p> <p>“ ❄ ” and “ ◊ ”</p>	<p>The room temperature will be controlled 2°C above the temperature and the FAN SPEED will be set to LOW setting 30 minutes after the setting of the sleep timer.</p> 
<p>Fan</p> <p>“ ✂ ”</p>	<p>The settings of room temperature and circulation are varied.</p>

NOTE

- If date or current time is not set, sleep timer can not be set.
- If you set the sleep timer after the off-, on/off- or off/on-timer has been set, the sleep timer becomes effective instead of the off-, on/off- or off/on-timer set earlier.
- You can not set other timer during sleep timer operation.
- After sleep timer time is up and when press sleep button again, the sleep timer will be set as last setting.
- Sleep timer effective only once.

ADJUSTING THE AIR DEFLECTOR

- 1** Adjustment of the conditioned air in the upward and downward directions.

The horizontal air deflector is automatically set to the proper angle suitable for each operation. The deflector can be swung up and down continuously and also set to the desired angle using the “ (AUTO SWING)” button.

- If the “ (AUTO SWING)” button is pressed once, the horizontal air deflector swings up and down. If the button is pressed again, the deflector stops in its current position. Several seconds (about 6 seconds) may be required before the deflector starts to move.
- Use the horizontal air deflector within the adjusting range shown on the right.
- When the operation is stopped, the horizontal air deflector moves and stops at the position where the air outlet closes.

CAUTION

- In “Cooling” operation, do not keep the horizontal air deflector swinging for a long time. Some dew may form on the horizontal air deflector and dew may drop.

- 2** Adjustment of the conditioned air to the left and right.

Hold the vertical air deflector as shown in the figure and adjust the conditioned air to the left and right.

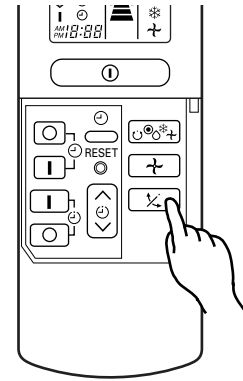
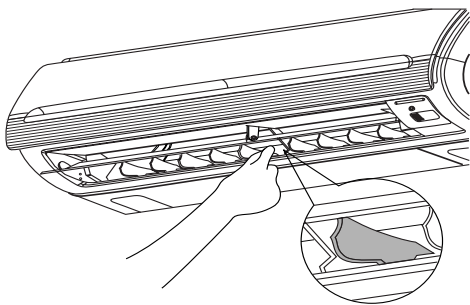

When cooling, dehumidifying

Vertical

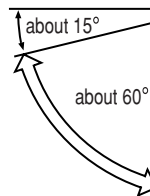

When heating

Vertical

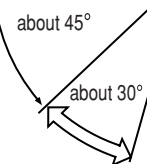

HOW TO EXCHANGE THE BATTERIES IN THE REMOTE CONTROLLER

1 Remove the cover as shown in the figure and take out the old batteries.



2 Install the new batteries.
The direction of the batteries should match the marks in the case.

⚠ CAUTION

1. Do not use new and old batteries, or different kinds of batteries together.
2. Take out the batteries when you do not use the remote controller for 2 or 3 months.

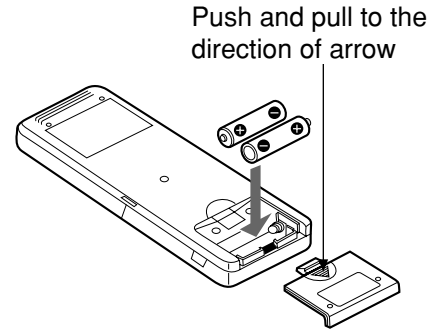

THE IDEAL WAYS OF OPERATION

Suitable Room Temperature

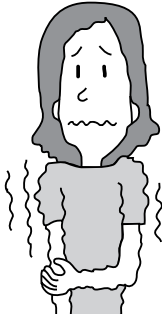

⚠ Warning
Freezing temperature is bad for health and a waste of electric power.

Install curtain or blinds

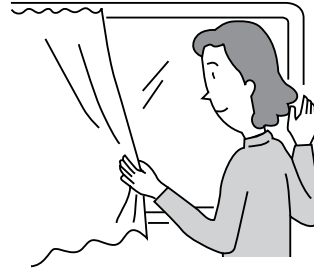

It is possible to reduce heat entering the room through windows.

Ventilation

⚠ Caution
Do not close the room for a long period of time. Occasionally open the door and windows to allow the entrance of fresh air.



Effective Usage Of Timer

At night, please use the “OFF or ON timer operation mode”, together with your wake up time in the morning. This will enable you to enjoy a comfortable room temperature. Please use the timer effectively.

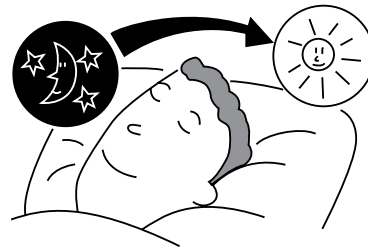

Do Not Forget To Clean The Air Filter

Dusty air filter will reduce the air volume and the cooling efficiency. To prevent from wasting electric energy, please clean the filter every 2 weeks.

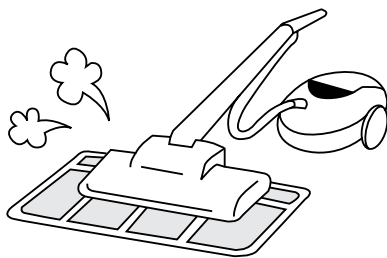

Please Adjust Suitable Temperature For Baby And Children

Please pay attention to the room temperature and air flow direction when operating the unit for baby, children and old folks who have difficulty in movement.

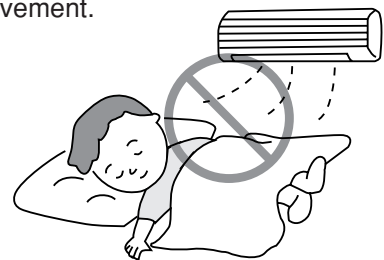

The Air Conditioner And The Heat Source In The Room

Caution

If the amount of heat in the room is above the cooling capability of the air conditioner (for example: more people entering the room, using heating equipments and etc.), the preset room temperature cannot be achieved.

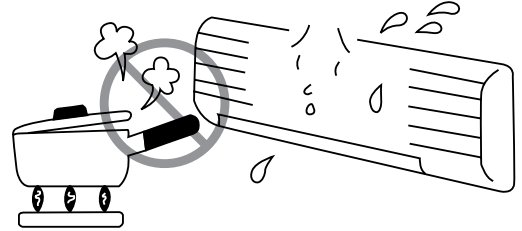

Not Operating For A Long Time

When the indoor unit is not to be used for a long period of time, please switch off the power from the mains. If the power from mains remains "ON", the indoor unit still consumes about 8W in the operation control circuit even if it is in "OFF" mode.

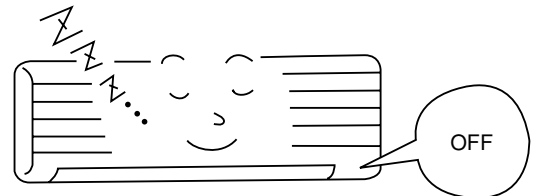

When Lightning Occurs

Warning

To protect the whole unit during lightning, please stop operating the unit and remove the plug from the socket.

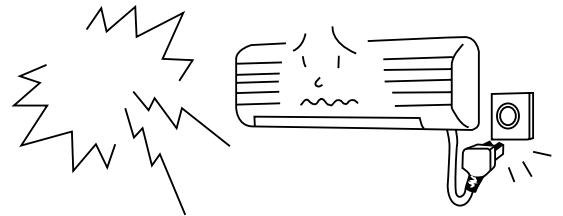

Interference From Electrical Products

Caution

To avoid noise interference, please place the indoor unit and its remote controller at least 1m away from electrical products.

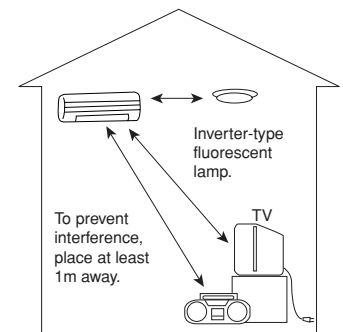

ATTACHING THE AIR CLEANSING AND DEODORIZING FILTERS

⚠ CAUTION

Cleaning and maintenance must be carried out only by qualified service personal. Before cleaning, stop operation and switch off the power supply.

1 Open the front panel.

- Pull up the front panel by holding it at both sides with both hands.

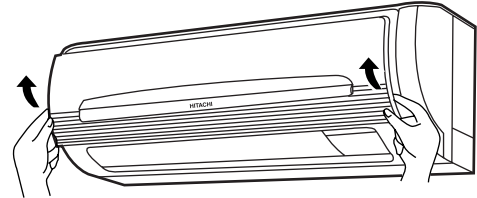

2 Remove the filter.

- Push upward to release the claws and pull out the filter.

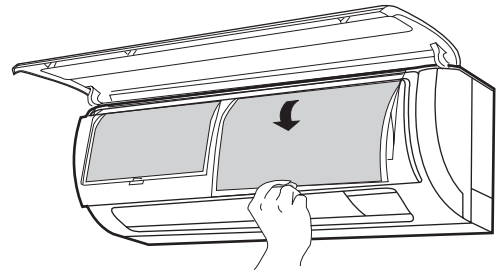

3 Attaching the Nano Titanium filters to the filter.

- Attach the Nano Titanium filters to the frame by gently compress its both sides and release after insertion into filter frame.

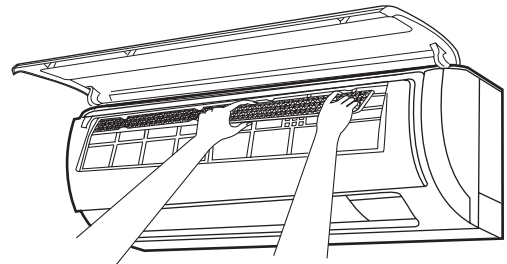

⚠ CAUTION

Do not bend the Nano Titanium filter as it may cause damage to the structure.

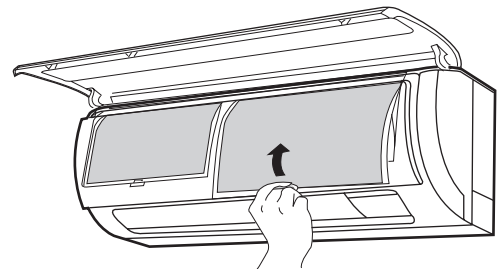

4 Attach the filters.

- Attach the filters by ensuring that the surface written "FRONT" is facing front.
- After attaching the filters, push the front panel at three arrow portion as shown in figure and close it.

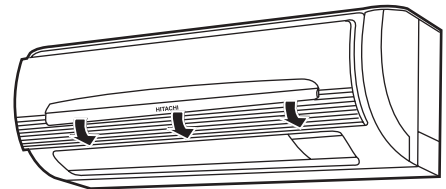

NOTE

- In case of removing the Nano Titanium filters, please follow the above procedures.
- The cooling capacity is slightly weakened and the cooling speed becomes slower when the Nano Titanium filters are used. So, set the fan speed to "HIGH" when using it in this condition.
- Nano Titanium filters are not washable and can be use in 1 year time. Type number for this air cleansing filter is <SPX-CFH15>. Please use this number for ordering when you want to renew it.
- Do not operate the air conditioner without filter. Dust may enter the air conditioner and fault may occur.

MAINTENANCE

⚠ CAUTION

Cleaning and maintenance must be carried out only by qualified service personal. Before cleaning, stop operation and switch off the power supply.

1. AIR FILTER

Clean the air filter, as it removes dust inside the room. In case the air filter is full of dust, the air flow will decrease and the cooling capacity will be reduced. Further, noise may occur. Be sure to clean the filter following the procedure below.

PROCEDURE

- 1 Open the front panel and remove the filter
 - Gently lift and remove the air cleansing and deodorizing filter from the air filter frame.

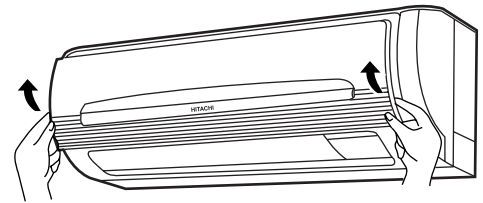

- 2 Vacuum dust from the air filter and air cleansing and deodorizing filter using vacuum cleaner. If there is too much dust, rinse under running tap water and gently brush it with soft bristle brush. Allow filters to dry in shade.

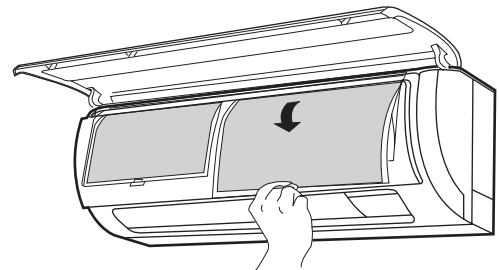
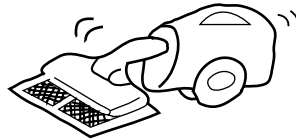

- 3
 - Re-insert the air cleansing and deodorizing filter to the filter frame. Set the filter with "FRONT" mark facing front, and slot them into the original state.
 - After attaching the filters, push the front panel at three arrow portions as shown in figure and close it.

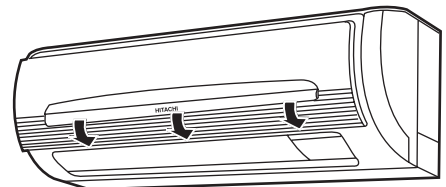

NOTE:

- Air cleansing and deodorizing filter should be cleaned every month or sooner if noticeable loading occurs. When used overtime, it may loose its deodorizing function. For maximum performance, it is recommended to replace it every 3-6 months depending on application requirements.

⚠ CAUTION

- Do not wash with hot water at more than 40°C. The filter may shrink.
- When washing it, shake off moisture completely and dry it in the shade; do not expose it directly to the sun. The filter may shrink.
- Do not use detergent on the air cleansing and deodorizing filter as some detergent may deteriorate the filter electrostatic performance.

2. Washable Front Panel

- Remove the front panel and wash with clean water.
Wash it with a soft sponge.
After using neutral detergent, wash thoroughly with clean water.
- When front panel is not removed, wipe it with a soft dry cloth. Wipe the remote controller thoroughly with a soft dry cloth.
- Wipe the water thoroughly.
If water remains at indicators or signal receiver of indoor unit, it causes trouble.

Method of removing the front panel.

Be sure to hold the front panel with both hands to detach and attach it.

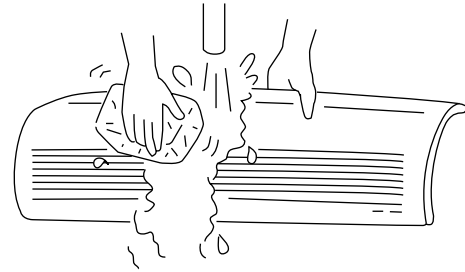

Removing the Front Panel

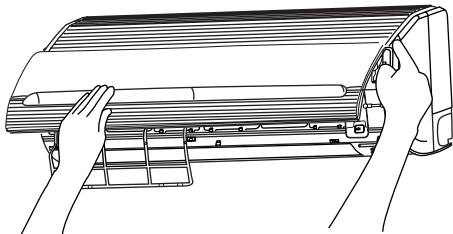

- When the front panel is fully opened with both hands, push the right arm to the inside to release it, and while closing the front panel slightly, put it out forward.

Attaching the Front Panel

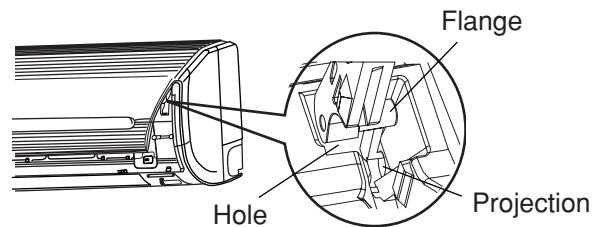

- Move the projections of the left and right arms into the **Flanges** in the unit and securely insert them into the holes.

⚠ CAUTION

- Do not splash or direct water to the body of the unit when cleaning it as this may cause short circuit.
- Never use hot water (above 40°C), benzine, gasoline, acid, thinner or a brush, because they will damage the plastic surface and the coating.



▲ CAUTION

Cleaning and maintenance must be carried out only by qualified service personal. Before cleaning, stop operation and switch off the power supply.

3. MAINTENANCE AT BEGINNING OF LONG OFF PERIOD

- Run the unit by setting the operation mode to ❄️ (COOL), the temperature to 32°C and the fan speed to HI for about half a day on a fine day, and dry the whole of the unit.
- Switch off the power plug.

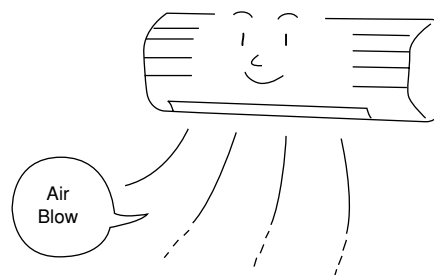

REGULAR INSPECTION

PLEASE CHECK THE FOLLOWING POINTS BY QUALIFIED SERVICE PERSONAL EITHER EVERY HALF YEARLY OR YEARLY. CONTACT YOUR SALES AGENT OR SERVICE SHOP.

<p>1</p>		<p>Is the earth line disconnected or broken?</p>
<p>2</p>		<p>Is the mounting frame seriously affected by rust and is the outdoor unit tilted or unstable?</p>
<p>3</p>		<p>Is the plug of power line firmly plugged into the socket? (Please ensure no loose contact between them).</p>

AFTER SALE SERVICE AND WARRANTY

WHEN ASKING FOR SERVICE, CHECK THE FOLLOWING POINTS.

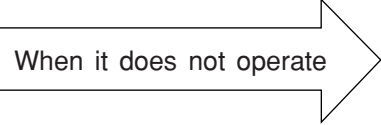
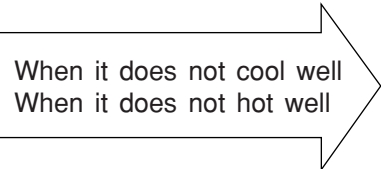
CONDITION	CHECK THE FOLLOWING POINTS
 <p>When it does not operate</p>	<ul style="list-style-type: none"> ● Is the fuse all right? ● Is the voltage extremely high or low? ● Is the circuit breaker "ON"?
 <p>When it does not cool well When it does not hot well</p>	<ul style="list-style-type: none"> ● Was the air filter cleaned? ● Does sunlight fall directly on the outdoor unit? ● Is the air flow of the outdoor unit obstructed? ● Are the doors or windows opened, or is there any source of heat in the room? ● Is the set temperature suitable?

Notes



- In quiet operation or stopping the operation, the following phenomena may occasionally occur, but they are not abnormal for the operation.
 - (1) Slight flowing noise of refrigerant in the refrigerating cycle.
 - (2) Slight rubbing noise from the fan casing which is cooled and then gradually warmed as operation stops.
- The odor will possibly be emitted from the room air conditioner because the various odor, emitted by smoke, foodstuffs, cosmetics and so on, sticks to it. So the air filter and the evaporator regularly must be cleaned to reduce the odor.

- Please contact your sales agent immediately if the air conditioner still fails to operate normally after the above inspections. Inform your agent of the model of your unit, production number, date of installation. Please also inform him regarding the fault.
- Power supply shall be connected at the rated voltage, otherwise the unit will be broken or could not reach the specified capacity.

