



HITACHI

SPLIT TYPE

INDOOR UNIT/OUTDOOR UNIT

MODEL

RAS-32CNH2/RAC-32CNH2

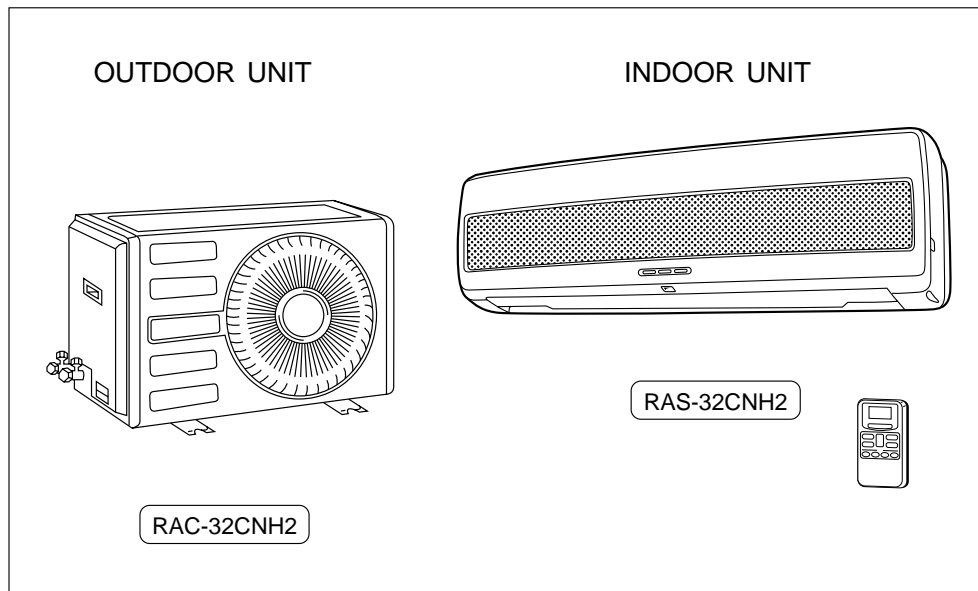



Instruction manual





Page 1~18



To obtain the best performance and ensure years of trouble free use, please read this instruction manual completely.





SAFETY PRECAUTION

- Please read the “Safety Precaution” carefully before operating the unit to ensure correct usage of the unit.
- Pay special attention to signs of “  **Warning**” and “  **Caution**”. The “Warning” section contains matters which, if not observed strictly, may cause death or serious injury. The “Caution” section contains matters which may result in serious consequences if not observed properly. Please observe all instructions strictly to ensure safety.
- “  ” sign in attached figure indicates prohibition.
- Please keep this manual after reading.

| PRECAUTIONS DURING INSTALLATION | |
|---|--|
|  WARNING | <ul style="list-style-type: none"> ● Please ask your sales agent or qualified technician for the installation of your unit. Water leakage, short circuit or fire may occur if you install the unit yourself. |
|  CAUTION | <ul style="list-style-type: none"> ● Please use earth line. Do not place the earth line near water or gas pipes, lightning-conductor, or the earth line of telephone. Improper installation of earth line may cause electric shock.  ● A circuit breaker should be installed depending on the mounting site of the unit. Without a circuit breaker, the danger of electric shock exists. ● Do not install near location where there is flammable gas. The outdoor unit may catch fire if flammable gas leaks around it.  ● Please ensure smooth flow of water when installing the drain hose. |

| PRECAUTIONS DURING SHIFTING OR MAINTENANCE | |
|---|---|
|  WARNING | <ul style="list-style-type: none"> ● Should abnormal situation arises (like burning smell), please stop operating the unit and turn off the circuit breaker. Contact your agent. Fault, short circuit or fire may occur if you continue to operate the unit under abnormal situation.  ● Please contact your agent for maintenance. Improper self maintenance may cause electric shock and fire. ● Please contact your agent if you need to remove and reinstall the unit. Electric shock or fire may occur if you remove and reinstall the unit yourself improperly. |

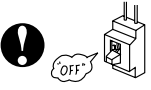
| PRECAUTIONS DURING OPERATION | |
|--|---|
| W A R N I N G | <ul style="list-style-type: none"> ● Avoid an extended period of direct air flow for your health.  |
| | <ul style="list-style-type: none"> ● Do not put objects like thin rods into the panel of blower and suction side because the high-speed fan inside may cause danger.  |
| | <ul style="list-style-type: none"> ● Do not use any conductor as fuse wire, this could cause fatal accident.  |
| | <ul style="list-style-type: none"> ● During thunder storm, disconnect and turn off the circuit breaker.  |



PRECAUTIONS DURING OPERATION

- The product shall be operated under the manufacturer specification and not for any other intended use.



- Do not attempt to operate the unit with wet hands, this could cause fatal accident.

- When operating the unit with burning equipments, regularly ventilate the room to avoid oxygen insufficiency.

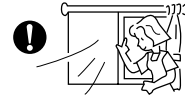

- Do not direct the cool air coming out from the air-conditioner panel to face household heating apparatus as this may affect the working of apparatus such as the electric kettle, oven etc.

- Please ensure that outdoor mounting frame is always stable, firm and without defect. If not, the outdoor unit may collapse and cause danger.



- Do not splash or direct water to the body of the unit when cleaning it as this may cause short circuit.

- Do not place plants directly under the air flow as it is bad for the plants.

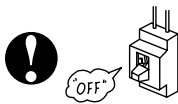
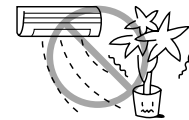

- Please switch off the unit and turn off the circuit breaker during cleaning, the high-speed fan inside the unit may cause danger.

- Turn off the circuit breaker if the unit is not to be operated for a long period.



- Do not climb on the outdoor unit or put objects on it.

- Do not put water container (like vase) on the indoor unit to avoid water dripping into the unit. Dripping water will damage the insulator inside the unit and causes short-circuit.

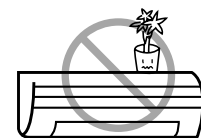

- When operating the unit with the door and windows opened, (the room humidity is always above 80%) and with the air deflector facing down or moving automatically for a long period of time, water will condense on the air deflector and drips down occasionally. This will wet your furniture. Therefore, do not operate under such condition for a long time.
- If the amount of heat in the room is above the cooling capability of the unit (for example: more people entering the room, using heating equipments and etc.), the preset room temperature cannot be achieved.

CAUTION



NAMES AND FUNCTIONS OF EACH PART

INDOOR UNIT

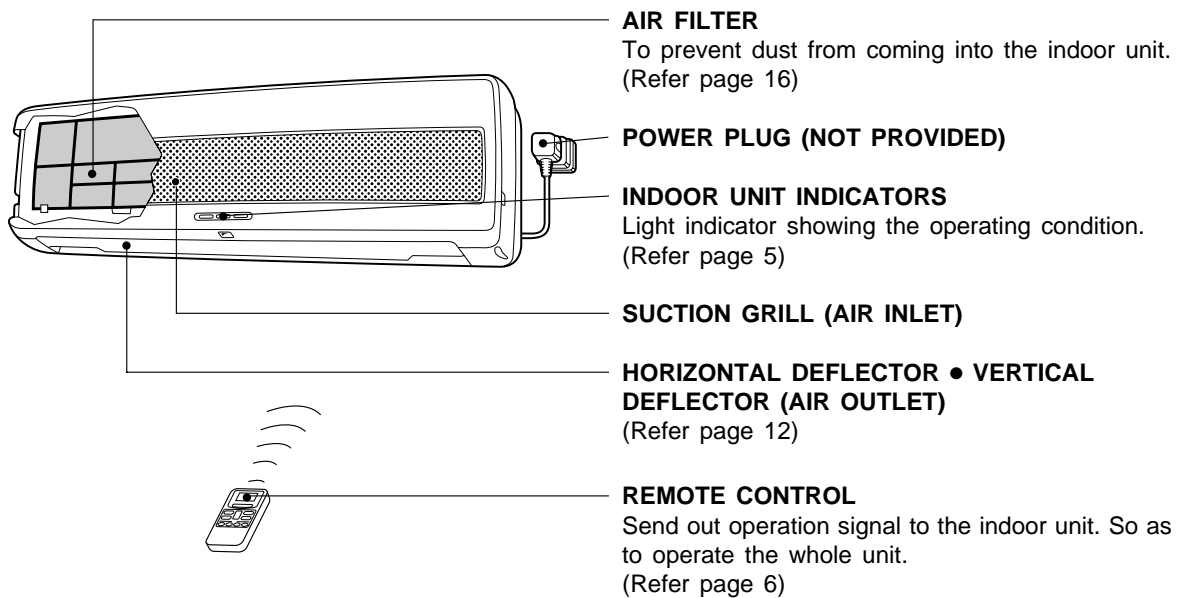

OUTDOOR UNIT

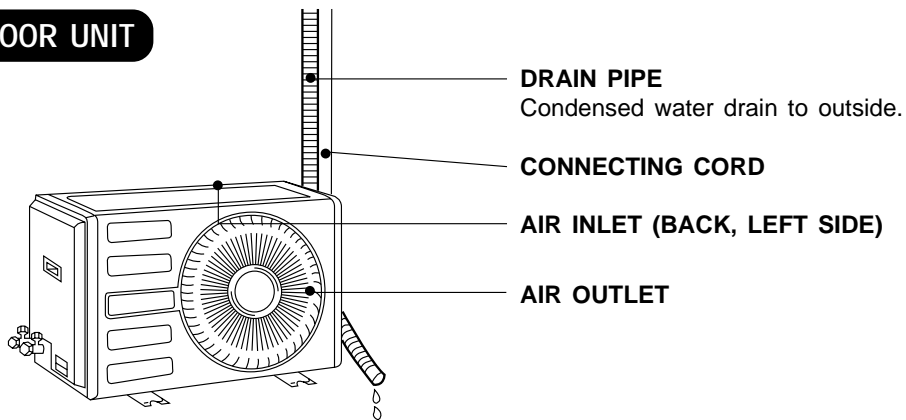

MODEL NAME AND DIMENSIONS

| MODEL | WIDTH (mm) | HEIGHT (mm) | DEPTH (mm) |
|------------|------------|-------------|------------|
| RAS-32CNH2 | 798 | 265 | 168 |
| RAC-32CNH2 | 820 | 520 | 280 |





OPERATION INDICATOR

SELECTOR SWITCH

AUTO START

Use this switch in order to set the unit to automatically switch ON after the power supply resuming from the power failure.

NORMAL

Use this switch in order to prevent the unit from switch ON after the power supply resuming from the power failure.

SELECTOR SWITCH IS PRESET AT NORMAL POSITION.

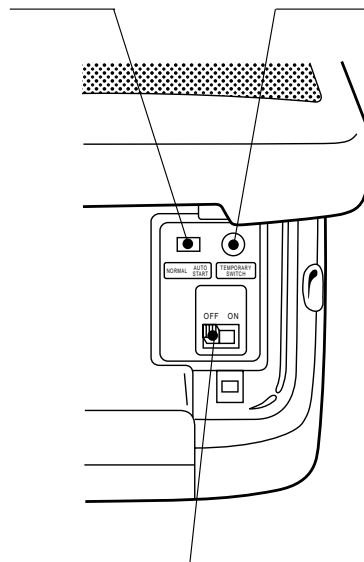

TEMPORARY SWITCH

Use this switch to start and stop when the remote controller does not work. Normally do not use this button.

POWER SWITCH

INDOOR UNIT INDICATORS

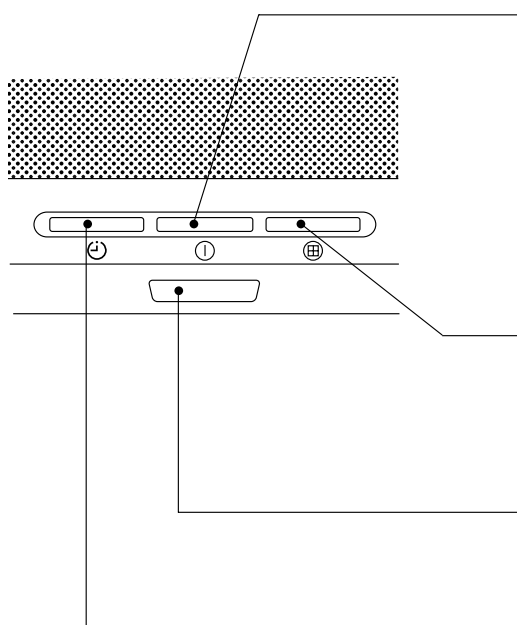

OPERATION LAMP

This lamp lights during operation. The OPERATION LAMP flashes in the following cases during heating.

(1) During preheating

For about 2–3 minutes after starting up.

(2) During defrosting

Defrosting will be performed about once an hour when frost forms on the heat exchanger of the outdoor unit, for 5–10 minutes each time.

FILTER LAMP

When the device is operated for a total of about 100 hours, the FILTER lamp lights to indicate that it is time to clean the filter. The lamp goes out when the POWER SWITCH set to OFF and ON again.

SIGNAL RECEIVER

There will be a beep sound when this receiver receives signal from remote controller.

TIMER LAMP

This lamp lights when the timer is working.



NAMES AND FUNCTIONS OF REMOTE CONTROL UNIT

- This controls the operation function and timer setting of the room air conditioner. The range of control is about 4 meters. If indoor lighting is controlled electronically, the range of control may be shorter.

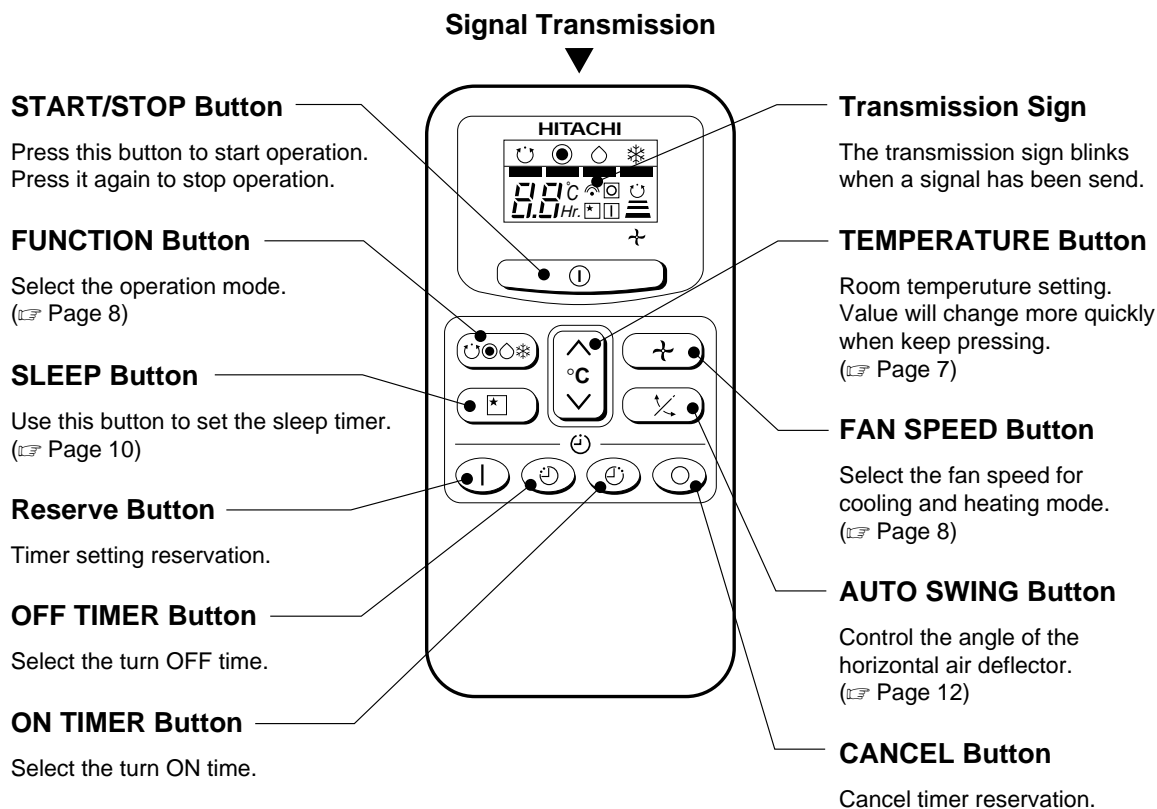

Precautions for Use

- Do not put the remote controller in direct sunlight and high temperature.
- Do not drop it on the floor, and protect it from water.
- If you press the FUNCTION button during operation, the air conditioner may stop for about 3 minutes for protection before you can start it again.

You can use the remote controller by fixing it on the wall with the accessory parts.

- Before fixing it, make sure the unit can be controlled by the remote control unit at the fixing position.

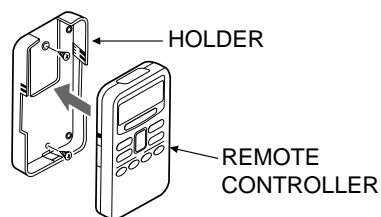



AUTOMATIC OPERATION

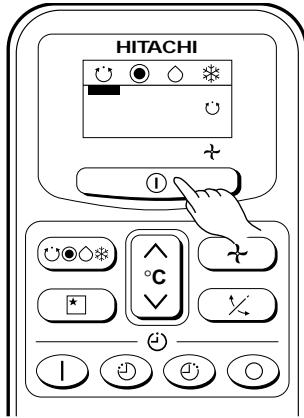

- The device will automatically determine the mode of operation, HEAT, COOL or DEHUMIDIFY, depending on the initial room temperature. The selected mode of operation will not change when the room temperature varies.



1 Press the (START/STOP) button

- Operation start with a “beep” sound.

STOP Press the (START/STOP) button

- Make sure the  (Automatic) mode have been selected by using the  (FUNCTION) button.
- The fan speed selector does not work at this operation.

- You can slightly adjust the room temperature.

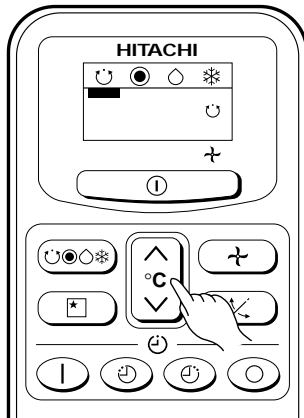

1 Press the (ROOM TEMPERATURE) button

- Temperature setting change by 1°C for each 1 time press.

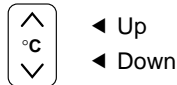

- You can raise or lower the temperature setting by a maximum of 3°C.
- The display does not indicate the preset temperature in the Automatic mode. Device will receive the setting by a “beep”.

CONDITION OF AUTOMATIC OPERATION

- The selected mode of operation will not change during the operation even though the room temperature change.

| INITIAL ROOM TEMPERATURE (APPROX.) | FUNCTION | TEMPERATURE SETTING | FAN SPEED |
|------------------------------------|----------|--|---|
| Over 27°C | ➔ COOL | 27°C | HIGH at start, LOW after the preset temperature is reached |
| 23 ~ 27°C | ➔ DRY | Slightly lower than the room temperature | LOW |
| Under 23°C | ➔ HEAT | 23°C | HIGH at start, MED or LOW after the preset temperature is reached |



MANUAL OPERATION [Heating • Dehumidify • Cooling]

- Please use under below condition when you want to set the function mode, room temperature and fan speed by manually.

| HEATING | DEHUMIDIFYING | COOLING |
|-----------------------------------|--------------------------------|-----------------------------------|
| Outdoor Temperature 21°C below | Room Temperature 16°C above | Outdoor Temperature 22°C above |

1 OPERATION MODE SELECTION

- Every time you press the button, the mode will change as the below sequence

☺ (Auto) → ● (Heat) → ○ (Dry) → ❄ (Cool)

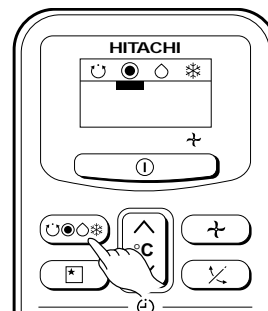

2 ROOM TEMPERATURE SETTING



◀ Up
◀ Down

Recommend Temperature

| | |
|------------|---------|
| Heating | 20~24°C |
| Dehumidify | 20~26°C |
| Cooling | 25~28°C |

- The cooling operation does not start if the temperature setting is higher than the current room temperature.

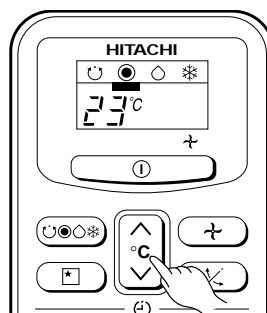

3 FAN SPEED SETTING

- Every time you press the button, fan speed will change as the below sequence.

HEATING } : AUTO → HIGH → MED → LOW
COOLING } : (☺ → ≡ → = → -)

DEHUMIDIFYING : LOW (FIXED)
: (-)

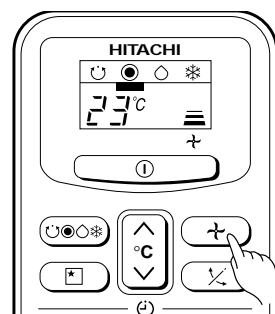

4 Press the (START/STOP) button

- Operation start with a signal received sound "beep".

STOP Press the (START/STOP) button

- As the settings are stored in memory in the remote control unit, you only have to press the (START/STOP) button in order to use the same setting next time.

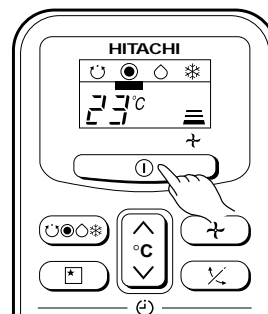



TIMER RESERVATION

■ ON Timer and OFF Timer are available.

OFF Timer Reservation

1 OFF TIME setting

- Select the OFF TIME by pressing the (OFF) Button.
- Setting time will change according to the below sequence when you press the button.

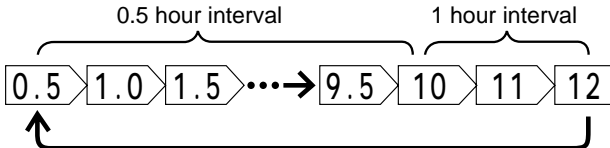

- The value change more quickly if you keep pressing the button.

2 Press the (Reserve) button

- OFF TIMER reserved with a signal received sound "beep".
- The (OFF) Mark starts lighting instead of blinking.

ON Timer Reservation

1 ON TIME setting

- Select the ON TIMER by pressing the (ON) Button.
- At the beginning of setting, time 6 hours was set.
- Setting time will change according to the below sequence.

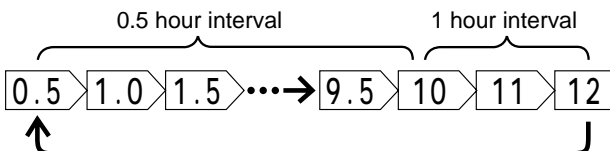

- The value change more quickly if you keep pressing the button.

2 Press the (Reserve) button

- ON TIMER reserved with a signal received sound "beep".
- The (ON) Mark starts lighting instead of blinking.

CANCELLATION of Timer Reservation

1 Press the (Cancel) button

- As the time settings are stored in remote controller memory, you only have to press the (Reserve) button in order to use the same setting next time.

■ Operation stop at setting time

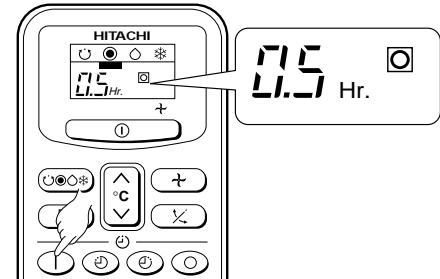
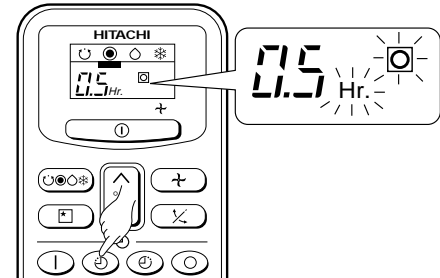

■ Operation will start for setting temperature at setting time (The starting time may different depend on the room temperature and set temperature).

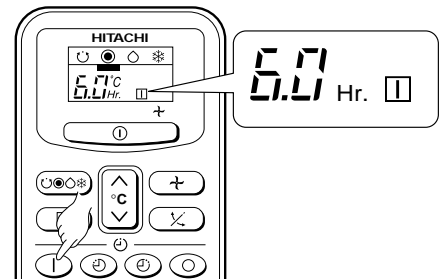
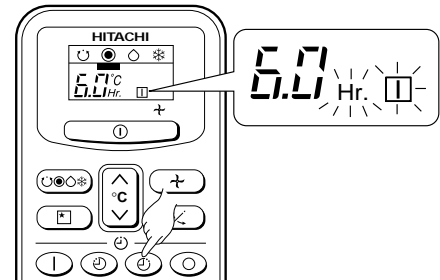



HOW TO SET THE SLEEP TIMER

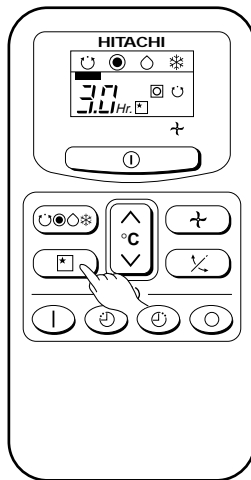

| Mode | Indication |
|-------------|---|
| Sleep timer | 1 hour → 2 hours → 3 hours → 7 hours Sleep timer off |

Sleep Timer: The device will continue working for the designated number of hours and then turn off. Point the signal window of the remote controller toward the indoor unit, and press the SLEEP button. The timer information will be displayed on the remote controller. The TIMER lamp lights with a beep from the indoor unit.

Example: Setting 3 hours sleep time.

How to Cancel Reservation

Point the signal window of the remote controller toward the indoor unit, and press the ○ (CANCEL) button. The ⏸ (RESERVED) sign goes out with a beep and the ⏰ (TIMER) lamp turns off on the indoor unit.

NOTE

If you set the sleep timer when the off-timer or on/off-timer has been set earlier, the sleep timer becomes effective instead of the off- or on/off-timer set earlier.



Explanation of the sleep timer

The device will control the FAN SPEED and room temperature automatically so as to be quiet and good for people's health. You can set the sleep timer to turn off after 1, 2, 3 or 7 hours. The FAN SPEED and room temperature will be controlled as shown below.

Operation with the sleep timer

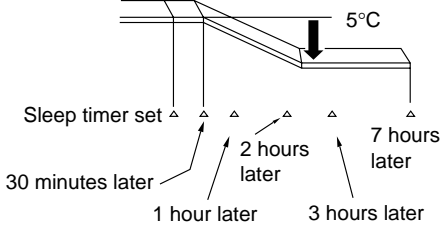
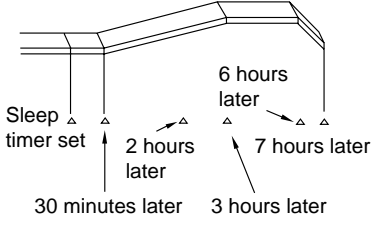
| Function | Operation |
|--|--|
| Heating “☉” | <p>The room temperature will be controlled 5°C below the temperature setting 30 minutes after the setting of the sleep timer. The FAN SPEED will be set to LOW immediately.</p> <p>The room temperature is kept at about 12°C minimum.</p>  |
| Cooling “❄️” and dehumidifying “💧” | <p>The FAN SPEED will be set to LOW immediately.</p> <p>The room temperature is kept at about 25–28°C.</p>  |
| Fan “✚” | <p>The settings of room temperature and circulation are not varied.</p> |



ADJUSTING THE AIR DEFLECTOR

- 1** Adjustment of the conditioned air in the upward and downward directions.

According to operation, the horizontal air deflector is automatically set to the proper angle suitable for each operation. The deflector can swing up and down and also set to the desired angle using the “ (AUTO SWING)” button. (If the angle of the deflector is changed, it will not return to the auto-set position after operations start unless the operation mode is switched.)

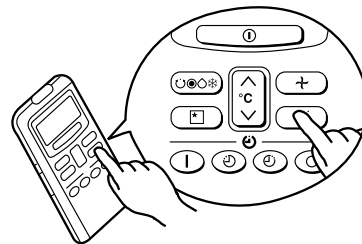

- If the “ (AUTO SWING)” button is pressed once, the horizontal air deflector swings up and down. If the button is pressed again, the deflector stops in its current position. Several seconds (about 6 seconds) may be required before the deflector starts to move.
- Use the horizontal air deflector within the adjusting range shown on the right.
- When the operation is stopped, the horizontal air deflector moves and stops at the position where the air outlet closes.

CAUTION

- In “Cooling” operation, do not keep the horizontal air deflector swinging for a long time. Some dew may form on the horizontal air deflector and some dew drops may fall from it.

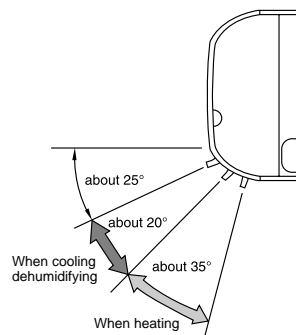

- 2** Adjustment of the conditioned air to the left and right.

Hold the vertical air deflector as shown in the figure and adjust the conditioned air to the left and right.

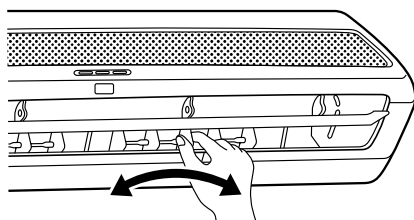



HOW TO EXCHANGE THE BATTERIES IN THE REMOTE CONTROLLER

- 1 Remove the cover as shown in the figure and take out the old batteries.



- 2 Install the new batteries. The direction of the batteries should match the marks in the case.

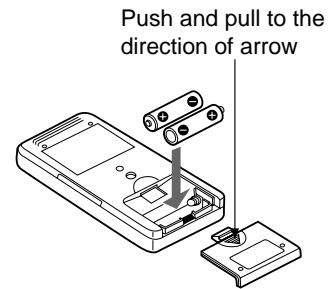

CAUTION

1. Do not use new and old batteries, or different kinds of batteries together.
2. Take out the batteries when you do not use the remote controller for 2 or 3 months.
3. The batteries must be of the LR03 type.

HOW TO EXCHANGE THE AIR CLEANING AND DEODORIZING FILTERS

- 1 Open the frame by releasing the claws from the filter holes.



- 2 Place the new air cleaning and deodorizing filters and attach the frame back to the filter.

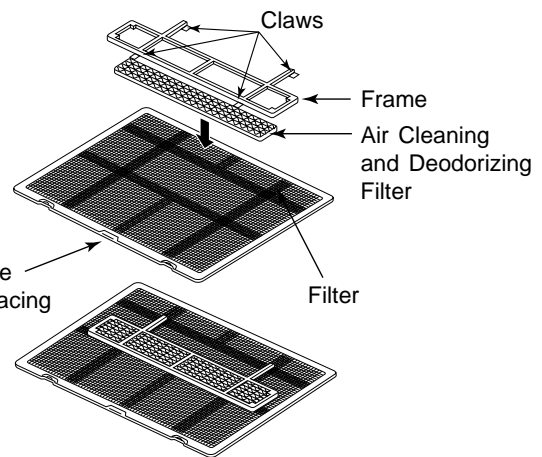

CAUTION

Do not bend the air cleansing and deodorizing filter as it may cause damage to the structure.



NOTE:

- The cooling capacity is slightly weakened and the cooling speed becomes slower when the air cleaning and deodorizing filter is used. So, set the fan speed to "HIGH" when using it in this condition.
- Air cleansing and deodorizing filters is washable and reusable up to 20 times by using vacuum cleaner or water rinse. Type number for this air cleaning filter is <SPX-CFH5>. Please use this number for ordering when you want to renew it.



THE IDEAL WAYS OF OPERATION

Suitable Room Temperature

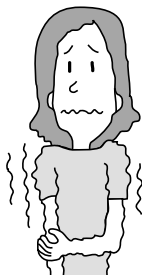

Warning
Freezing temperature is bad for health and a waste of electric power.

Install curtain or blinds

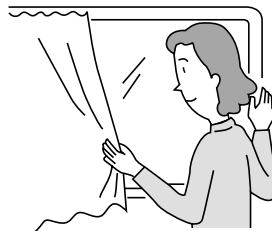

It is possible to reduce heat entering the room through windows.

Ventilation

Caution
Do not close the room for a long period of time. Occasionally open the door and windows to allow the entrance of fresh air.



Effective Usage Of Timer

At night, please use the "OFF or ON timer operation mode", together with your wake up time in the morning. This will enable you to enjoy a comfortable room temperature. Please use the timer effectively.

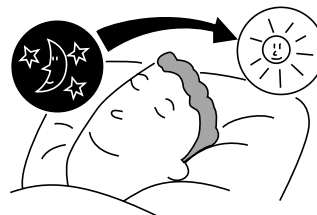

Do Not Forget To Clean The Air Filter

Dusty air filter will reduce the air volume and the cooling efficiency. To prevent from wasting electric energy, please clean the filter every 2 weeks.

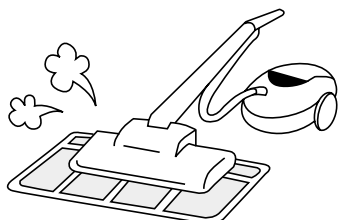

Please Adjust Suitable Temperature For Baby And Children

Please pay attention to the room temperature and air flow direction when operating the unit for baby, children and old folks who have difficulty in movement.

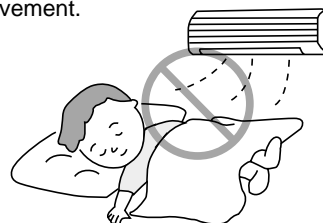



FOR USER'S INFORMATION

The Air Conditioner And The Heat Source In The Room

Caution

If the amount of heat in the room is above the cooling capability of the air conditioner (for example: more people entering the room, using heating equipments and etc.), the preset room temperature cannot be achieved.

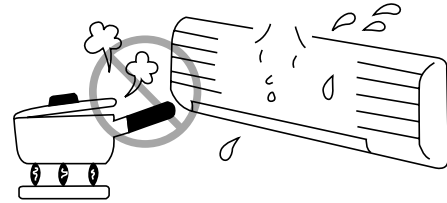

After Power Failure

When the power is resumed after a power failure, the indoor unit will still remain "OFF". To operate the unit, please press the "ON/OFF" button again.

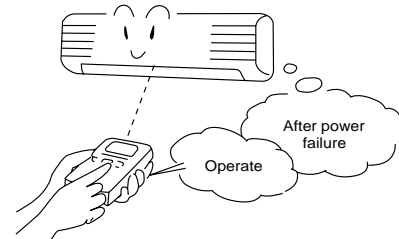

Not Operating For A Long Time

When the indoor unit is not to be used for a long period of time, please switch off the power from the mains. If the power from mains remains "ON", the indoor unit still consumes about 8W in the operation control circuit even if it is in "OFF" mode.

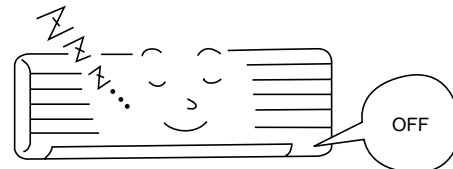

When Lightning Occurs

Warning

To protect the whole unit during lightning, please stop operating the unit and remove the plug from the socket.

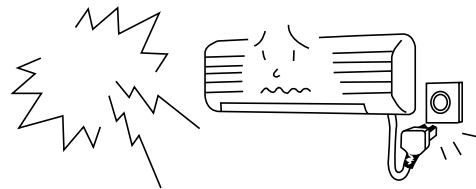



MAINTENANCE

⚠ CAUTION

Before the cleaning, stop operation and disconnect the power supply.

1. AIR FILTER

Clean the air filter, as it removes dust inside the room. In case the air filter is full of dust, the air flow will decrease and the cooling capacity will be reduced. Further, noise may occur. Be sure to clean the filter following the procedure below.

PROCEDURE

- 1 Open the front panel and remove the filter
 - Slightly lift the filter and release the claws from the front cover.
 - Gently lift and remove the air cleansing and deodorizing filter from air filter frame.

- 2
 - Vacuum dust from the air filter and air cleansing and deodorizing filter using vacuum cleaner. If there is too much dust, rinse under running tap water and gently brush it with soft bristle brush. Allow filters to dry in shade.



- 3
 - Re-insert the air cleansing and deodorizing filter to the filter frame. Set the filter with "FRONT" mark facing front, and slot them into the original state.
 - After attaching the filters, push the front panel at three arrow portions as shown in figure and close it.

REMOVING METHOD

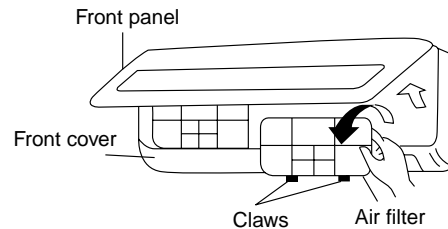
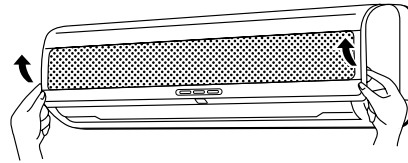

INSTALLATION METHOD

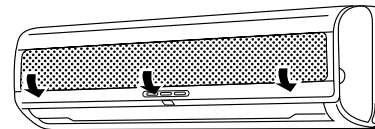
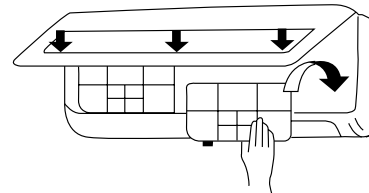

NOTE:

- Air cleansing and deodorizing filter should be cleaned every month or sooner if noticeable loading occurs. When used overtime, it may lose its deodorizing function. For maximum performance, it is recommended to replace it every 3-6 months depending on application requirements.

⚠ CAUTION

- Do not wash with hot water at more than 40°C. The filter may shrink.
- When washing it, shake off moisture completely and dry it in the shade; do not expose it directly to the sun. The filter may shrink.
- Do not use detergent on the air cleansing and deodorizing filter as some detergent may deteriorate the filter electrostatic performance.



2. Washable Suction Grille

- The suction grille remove and can wash with clean water in whole. Wash it with a soft sponge. After using neutral detergent, wash thoroughly with clean water.
- When it is not removed, wipe it with a soft dry cloth. Wipe the remote controller thoroughly with a soft dry cloth.
- Wipe the water thoroughly. If the water remains at indicators or signal receiver of indoor unit, it causes trouble.

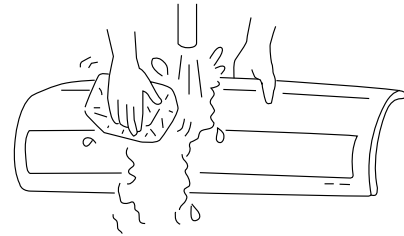

Method to remove of the suction grille.
Be sure to hold the suction grille with both hands to detach and attach it.

Removing the Suction Grille

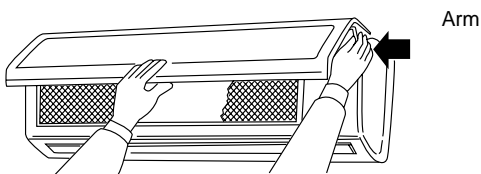

- When the suction grille is fully opened with both hands, push the right arm to the inside to release it, and while closing the suction grille slightly, put it out forward.

Attaching the Suction Grille

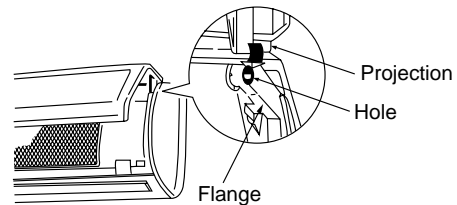

- Move the projections of the left and right arms into the **Flanges** in the unit and securely insert them into the holes.

CAUTION

- Do not splash or direct water to the body of the unit when cleaning it as this may cause short circuit.
- Never use hot water (above 40°C), benzine, gasoline, acid, thinner or a brush, because they will damage the plastic surface and the coating.





3. MAINTENANCE AT BEGINNING OF LONG OFF PERIOD

- Running the unit setting the operation mode to ❄️ (COOL), the temperature to 32°C and the fan speed to HI for about half a day on a fine day, and dry the whole of the unit.
- Disconnect the power plug.

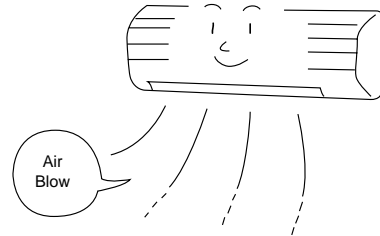

REGULAR INSPECTION

PLEASE CHECK THE FOLLOWING POINTS EVERY EITHER HALF YEARLY OR YEARLY. CONTACT YOUR SALES AGENT SHOULD YOU NEED ANY HELP.

| | | |
|---|--|---|
| 1 | | <p>Is the plug of power line firmly plugged into the socket? (Please ensure no loose contact between them).</p> |
| 2 | | <p>Is the earth line disconnected or broken?</p> |
| 3 | | <p>Is the mounting frame seriously affected by rust and is the outdoor unit tilted or unstable?</p> |



AFTER SALE SERVICE AND WARRANTY

WHEN ASKING FOR SERVICE, CHECK THE FOLLOWING POINTS.

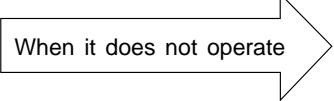
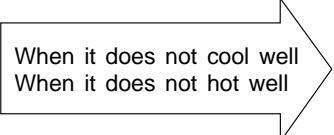
| CONDITION | CHECK THE FOLLOWING POINTS |
|--|---|
|  <p>When it does not operate</p> | <ul style="list-style-type: none"> ● Is the fuse all right? ● Is the voltage extremely high or low? ● Is the circuit breaker "ON"? |
|  <p>When it does not cool well When it does not heat well</p> | <ul style="list-style-type: none"> ● Is the air filter blocked with dust? ● Does sunlight fall directly on the outdoor unit? ● Is the air flow of the outdoor unit obstructed? ● Are the doors or windows opened, or is there any source of heat in the room? ● Is the set temperature suitable? |



Notes

- In quiet operation or stopping the running, the following phenomena may occasionally occur, but they are not abnormal for the operation.
 - (1) Slight flowing noise of refrigerant in the refrigerating cycle.
 - (2) Slight rubbing noise from the fan casing which is cooled and then gradually warmed as operation stops.
- The odor will possibly be emitted from the room air conditioner because the various odor, emitted by smoke, foodstuffs, cosmetics and so on, sticks to it. So please clean the air filter and the evaporator regularly to reduce the odor.

- Please contact your sales agent immediately if the air conditioner still fails to operate normally after the above inspections. Inform your agent of the model of your unit, production number, date of installation. Please also inform him regarding the fault.
- Power supply shall be connected at the rated voltage, otherwise the unit will be broken or could not reach the specified capacity.

